

Accordion Doors
Product Manual

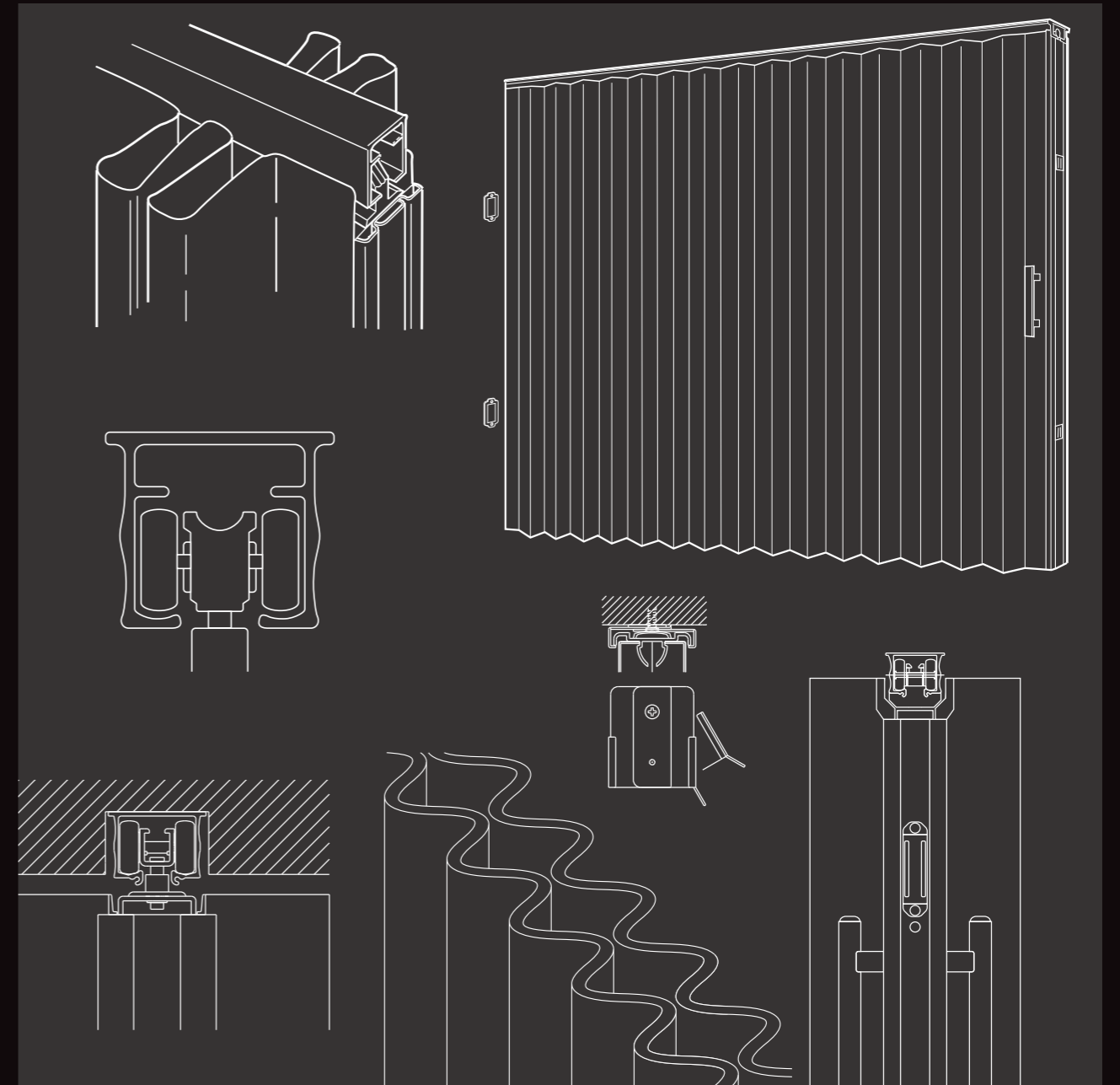

Accordion Doors
Product Manual

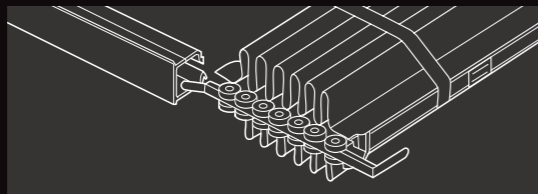
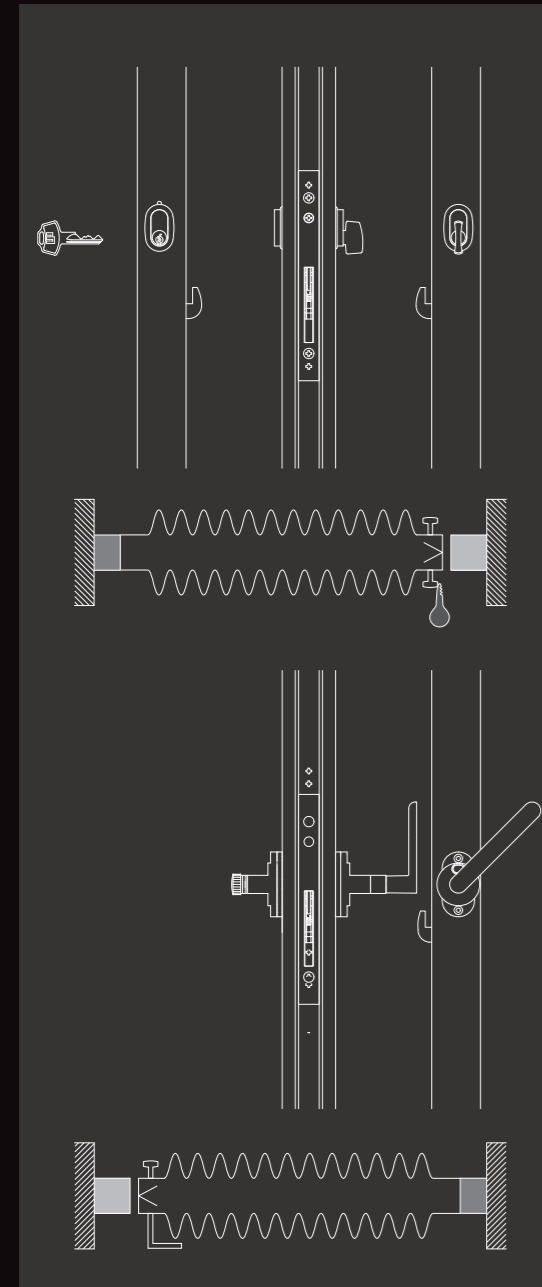

Contents

Product Line-up P. 02

Specifications • Structure

 CLOZA EXCEL P. 03

 CLOZA LIGHT P. 05

Options P. 07

Maintenance P. 15

How to Order P. 17

Order Form P. 18

Accordion Doors Product Manual



Product Line-up

	CLOZA EXCEL High-grade type, widely allowable to use.	CLOZA LIGHT Standard type, Operability is light and smooth.
Product Name		
Structure	Duplex <p>The double structure that the inside is pantograph-shape framework, and paste the Fabric on it.</p>	Duplex <p>The double structure that the inside is pantograph-shape framework, and paste the Fabric on it.</p>
Allowable Size	Product width: 550-5,000 mm Product height: 610-3,200 mm	Product width: 600-3,000 mm Product height: 1,610-2,400 mm
Available Colors	66 colors	61 colors
Track and Handle Color	White Platinum Gray Dark Bronze	White Platinum Gray
Optional Specs	Long Handle type Both Sides Handle type Front and back different Fabric type Upper part see-through type Inlay system type Lock system type Handle lock system type Curved type Cut-out	Both sides Handle type Front and back different Fabric type Inlay system type Curved type *For customized products only.
Reference	Page 03	Page 05

CLOZA EXCEL

Product Overview

● Structure Drawing

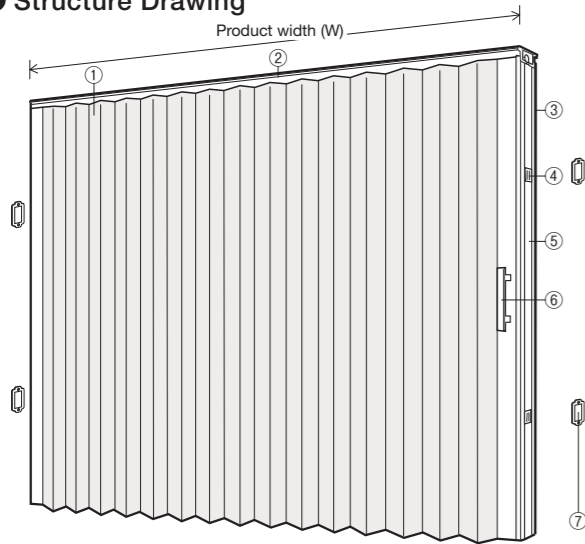

Components	Materials
① Fabric	PVC
② Track	aluminum extrusion
③ Frame Cover	aluminum extrusion
④ Magnet	stainless steel press forming, plastic molded, ferrite magnet
⑤ Frame Cushion	plastic molded extrusion
⑥ Handle [antibacterial]	aluminum alloy
⑦ Magnet Adsorption Plate	stainless steel press forming

● Attachments

Magnet Adsorption Plate

Product Height (H)	Number of Plate
-2,200 mm	4
-2,210 mm	6

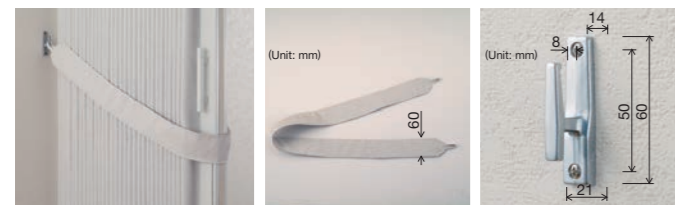

Magnet Adsorption Plate

Attached to the product width is 4,510 mm or more, or the product of curved type.

	Owo-way Draw	Split Draw
Tieback (using the same Fabric)	1	2
Tieback Hook Type F	2	4

● Available Color Table for Standard Parts

Parts color can be selected from the following three colors. If not specified, we apply a recommended Fabric color.

	White	Platinum Gray	Dark Bronze
Track			
Handle			
Magnet Adsorption Plate			

● Side View

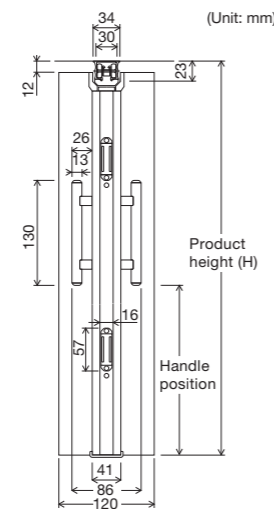

● Handle Position

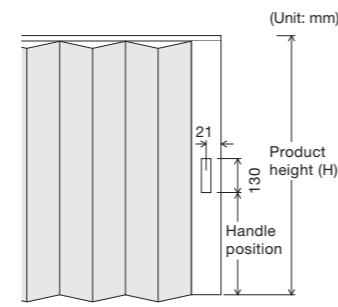

Product Height (H)	Handle Position
610-900	H - 315
910-1,200	H - 515
1,210-1,700	H - 595
1,710-1,800	H - 695
1,810-1,900	H - 795
1,910-2,000	H - 895
2,010-2,100	H - 995
2,110-2,300	H - 1,095
2,310-2,400	H - 1,195
2,410-2,500	H - 1,295
2,510-2,600	H - 1,395
2,610-2,700	H - 1,495
2,710-2,800	H - 1,595
2,810-2,900	H - 1,695
2,910-3,000	H - 1,795
3,010-3,100	H - 1,895
3,110-3,200	H - 1,995

● Track Cross Section

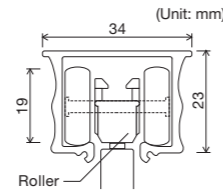

● Number of the Track

Product Width (W)	Number of the Track
550-1,200 mm	1
1,210-1,650 mm	1
1,660-2,400 mm	1
2,410-3,300 mm	1
3,310-4,000 mm	1
4,010-4,500 mm	1 *Option
	2 *Standard
4,510-4,800 mm	2
4,810-5,000 mm	2

*If the product width is between 4,010 - 4,500 mm, jointing two Tracks is the standard specification. One Track type is allowable by optional, please inquire the transportation method and specify the size.

Allowable Size

Product Width (W)	550-5,000
Product Height (H)	610-3,200

*For ordering, round down the nearest 10 mm both in width and in height.
*Maximum allowable size: One-way draw is of 5 m; Split draw is of 10 m.

Stack-up Guide

Product Width (W)	Stacked-up Height	Product Width (W)	Stacked-up Height
900	215	3,300	575
1,200	265	3,600	620
1,500	305	4,000	695
1,800	355	4,200	720
2,100	405	4,500	770
2,400	430	4,800	820
2,700	480	5,000	870
3,000	550		

Product Weight Guide

Product width 1,000 mm × Product height 2,000 mm: 10 kg
Product width 1,500 mm × Product height 2,000 mm: 14 kg
Product width 2,000 mm × Product height 2,000 mm: 16 kg

Installation Method

1. Installing of the main unit



Caution
Installing and removing should be done always by two people.
Fabric that tied the door body should not remove until the installing is end.

- Remove the Track Side Cover, pass through Rollers of the body to the Track, set the Track on the body, and disconnect the Alignment Plate slowly with pliers.

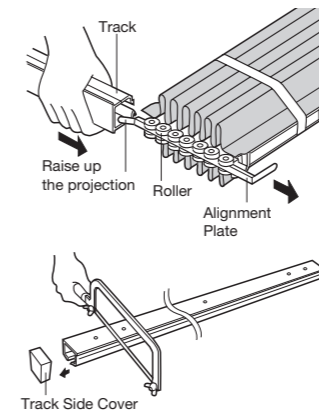

[For cutting the Track]
Remove the Track Side Cover, and cut the Track with hacksaw. Clean up metal chips remaining in the Track.

- Lift up the body, and attach the Track with screws (pan $\phi 3.5 \times 25$). (One person hold the body, and the other person attach the Track.) Install the Track with screws in order: first in the center of the Track ①, and next both ends ②.

*Be careful not to scrape the Track with a screwdriver so as not to become worse the slipping of Rollers.

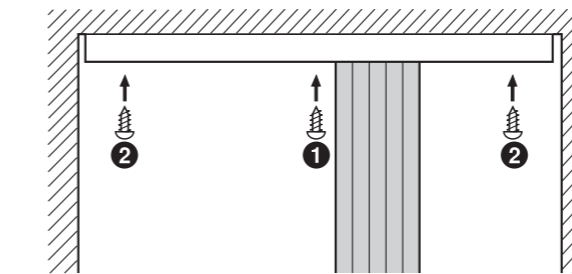

[For connecting Tracks]

- First, attach one Track to the body.
- Attach the Splice Pin to the other Track, and joint them not to make any gap in the seam of both Tracks.
- Slide the Splice Pin in the seam of Tracks by using a fine-tipped tool such as a flat-blade screwdriver.

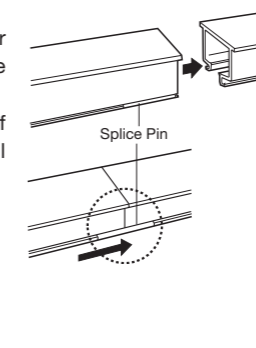

*In the case of split draw, attach the Intermediate Stop in the connect part.

- Attach the Magnet Adsorption Plate with screw (countersunk $\phi 3.1 \times 16$) to fit the Magnet position of the body.

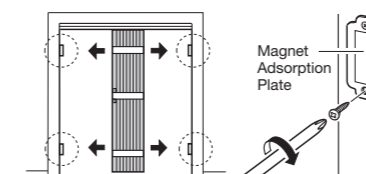

- Remove the Fabric that tied the body.

2. Removing of the main unit



Caution
Because it is dangerous to drop and fall down the main body, another person should always sustain the main body by hand.

- Fold up the body, and move to the center.
- Previously remove the screws at both ends ①, and remove the screw of the center last ②.

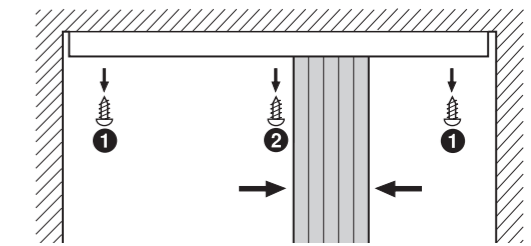

Operation Method

Opening and closing should always be done by gripping the Handle.

How to Take Measurements

*For the product dimensions, specify to round down the nearest 10 mm.

Width: internal dimensions of a door frame.

Height: subtract approx. 20 mm from the height of the opening height.

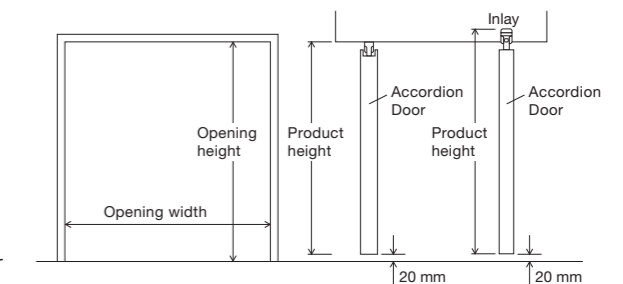

*Product height: from the Track top to the bottom of the product body

Subtract approx. 20 mm from the top of the carpet if you lay the carpet.

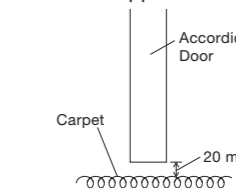

CLOZA LIGHT

Product Overview

● Structure Drawing

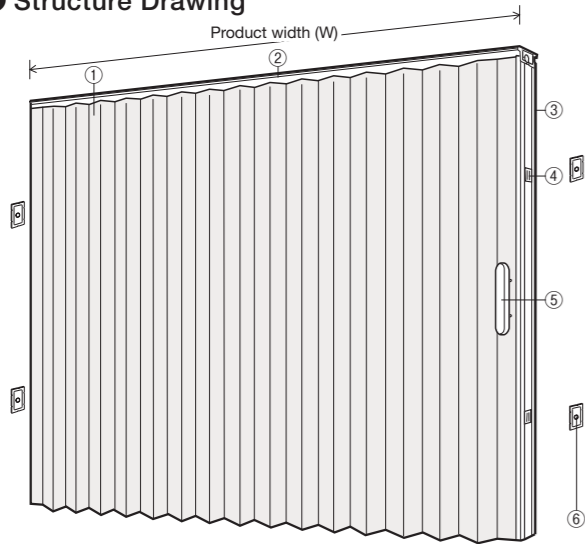

Components	Materials
① Fabric	PVC
② Track	aluminum extrusion
③ Frame Cover	aluminum extrusion
④ Magnet	stainless steel press forming, plastic molded, ferrite magnet
⑤ Handle [antibacterial]	plastic molded
⑥ Magnet Adsorption Plate	stainless steel press forming

● Attachments

Magnet Adsorption Plate

Product Height (H)	Number of Plate
-2,200 mm	4
-2,210 mm	6

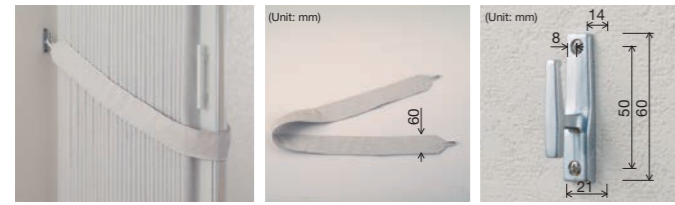

Tieback (using the same Fabric) Tieback Hook / Type F (Silver)

Magnet Adsorption Plate

Attached to the product width is the product of curved type.

	Owo-way Draw	Split Draw
Tieback (using the same Fabric)	1	2
Tieback Hook Type F	2	4

● Available Color Table for Standard Parts

Parts color can be selected from the following two colors. If not specified, we apply a recommended Fabric color.

	White	Platinum Gray
Track		
Handle		
Magnet Adsorption Plate		

● Side View

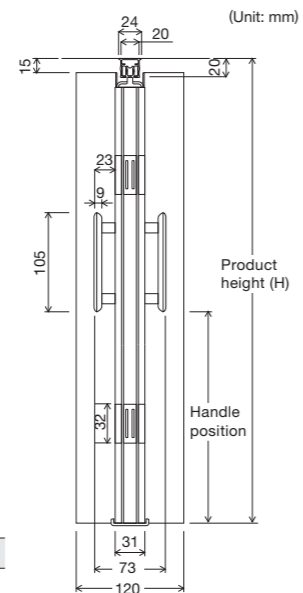

● Handle Position

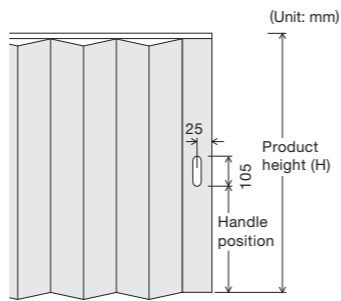

Product Height (H)	Handle Position
1,610-1,800	H - 700
1,810-1,900	H - 860
1,910-2,000	H - 960
2,010-2,100	H - 1,000
2,110-2,300	H - 1,100
2,310-2,400	H - 1,200

● Track Cross Section

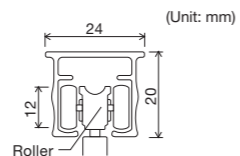

Allowable Size

[Customized product]		(Unit: mm)	*For ordering, round down the nearest 10 mm both in width and in height.
Product Width (W)	550-5,000		*Maximum allowable size: One-way draw is of 3 m; Split draw is of 6 m.
Product Height (H)	610-3,200		

[Standard product]		(Unit: mm)	*Only TD-5055 and 5056.
Product Width (W)	550-5,000		
Product Height (H)	610-3,200		

Stack-up Guide

Product Width (W)	Stacked-up Height	Product Width (W)	Stacked-up Height
1,000	245	2,250	410
1,250	265	2,500	435
1,500	295	2,750	485
1,750	335	3,000	530
2,000	360		

Product Weight Guide

Product width 1,000 mm × Product height 2,000 mm:	7.0 kg
Product width 1,500 mm × Product height 2,000 mm:	9.5 kg
Product width 2,000 mm × Product height 2,000 mm:	12.5 kg

Installation Method

1. Installing of the main unit

Caution
Installing and removing should be done always by two people. Fabric that tied the door body should not remove until the installing is end.

- Remove the Track Side Cover, pass through Rollers of the body to the Track, set the Track on the body, and disconnect the Alignment Rod slowly with pliers.

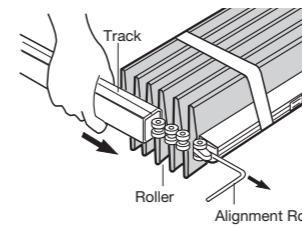

[When you cut the Track]
Remove the Track Side Cover, and cut the Track of opposite side of the Roller Stop Screw Hole with hacksaw. Clean up metal chips remaining in the Track.

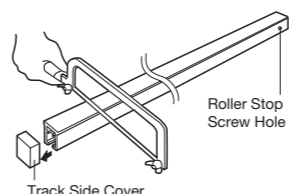

- Lift up the body, and attach the Track with screws (pan $\phi 3.5 \times 25$). (One person hold the body, and the other person attach the Track.) Install the Track with screws in order: first in the center of the Track ①, and next both ends ②.

*Be careful not to scrape the Track with a screwdriver so as not to become worse the slipping of Rollers.

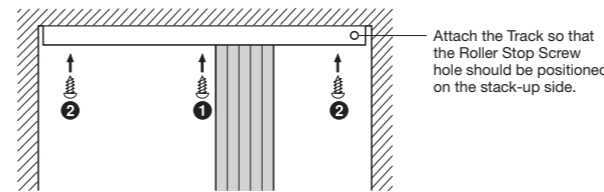

[For the split draw]

- First, attach one Track to the body.
- Attach another Track, and not to make any gap in the seam of Track.
- Attach the Intermediate Stop in the connect part.

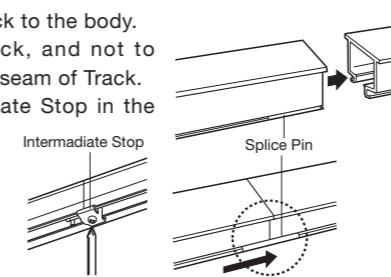

- Attach the Magnet Adsorption Plate with screw (countersunk $\phi 3.1 \times 16$) to fit the Magnet position of the body.

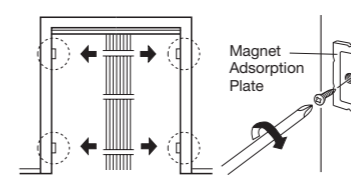

[For fixing one side with the one-way draw]

Fix the Pilot Roller on the fixed side with the Roller Stop Screw (pan $\phi 3.1 \times 20$).

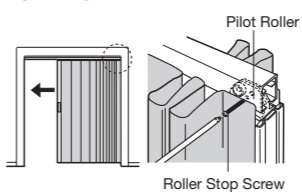

- Remove the Fabric that tied the body.

2. Removing of the main unit

Caution
Because it is dangerous to drop and fall down the main body, another person should always sustain the main body by hand.

- Fold up the body, and move to the center.
- Previously remove the screws at both ends ①, and remove the screw of the center last ②.

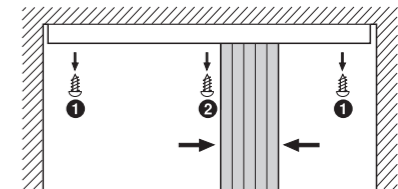

Operation Method

Opening and closing should always be done by gripping the Handle.

How to Take Measurements

*For the product dimensions, specify to round down the nearest 10 mm.

[Customized product]

Width: internal dimensions of a door frame.
Height: subtract approx. 20 mm from the height of the opening height.

[Standard product]

Choose the size that fits to the mounting location from in the lineup.

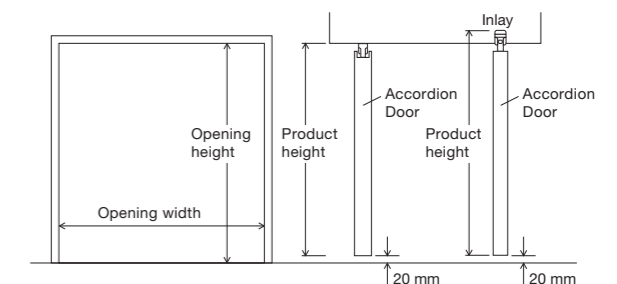

*Product height: from the Track top to the bottom of the product body

Subtract approx. 20 mm from the top of the carpet if you lay the carpet.

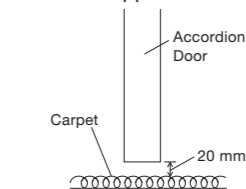

Options

Option Specifications

Long Handle Type

Antibacterial

Long Handle type easier to grip than normal Handle. The elderly and wheelchair users, as well as healthy people are able to grip the Handle in a natural posture. The surface has been applied antibacterial processing and it is clean.



TD-5053
Long Handle: Platinum Gray

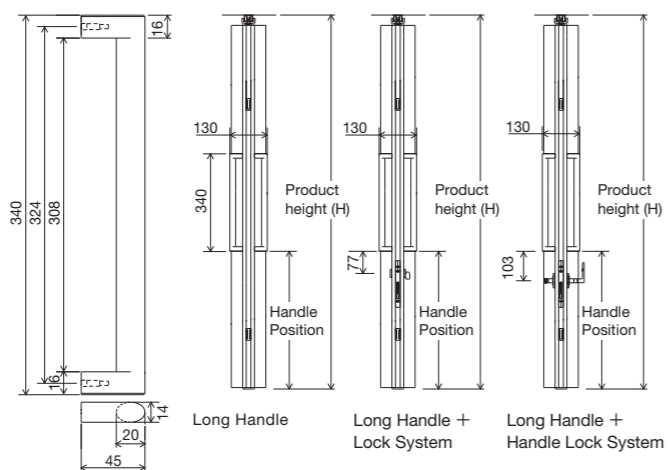

Available Types

○: allowable ×: non-allowable

CLOZA EXCEL	○
CLOZA LIGHT	×

Price

One-way draw
Standard price+3,000 Yen (tax excluded)
*One pair for the front and back Fabrics.

Split draw
Standard price+6,600 Yen (tax excluded)
*Two pairs for the front and back Fabrics.

(Unit: mm)

Product Height (H)	Handle Position	Product Height (H)	Handle Position	Product Height (H)	Handle Position
610-1,000	none	2,010-2,100	H - 1,226	2,710-2,800	H - 1,826
1,010-1,200	H - 746	2,110-2,300	H - 1,326	2,810-2,900	H - 1,926
1,210-1,700	H - 826	2,310-2,400	H - 1,426	2,910-3,000	H - 2,026
1,710-1,800	H - 926	2,410-2,500	H - 1,526	3,010-3,100	H - 2,126
1,810-1,900	H - 1,026	2,510-2,600	H - 1,626	3,110-3,200	H - 2,226
1,910-2,000	H - 1,126	2,610-2,700	H - 1,726		

Attachment Position

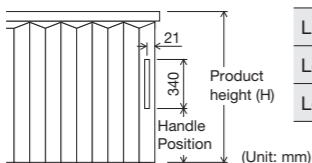

Allowable Attachment Height

Long Handle	Product height: 1,010 mm or more
Long Handle + Lock System	Product height: 1,210 mm or more
Long Handle + Handle Lock System	Product height: 1,210 mm or more

Both Sides Handle Type

Antibacterial

It is possible to attach the Handle on both sides. If you want to open and close from every side of left or right, it is recommended.



Available Types

○: allowable ×: non-allowable

CLOZA EXCEL	○
CLOZA LIGHT	○

Price

One-way draw
Standard price+2,600 Yen (tax excluded)
*One pair for the front and back Fabrics.

Split draw
Standard price+5,200 Yen (tax excluded)
*Two pairs for the front and back Fabrics.

Front and Back Different Fabric Type

You can choose different pattern of Fabrics in the front and back surface. As a partition, it is recommended in the place where is the taste of the room is different.

Caution

In the case of CLOZA EXCEL Handle lock type, please specify the Handle position as well as front and back Fabrics.

CLOZA EXCEL

*See-through Fabric (TD-5011-5015) is not available.
*Parts color is standard color of surface Fabric. Some color other than standard color also can choose.

CLOZA LIGHT

*Parts color is standard color of surface Fabric, however back side Handle color is standard color of back surface Fabric. Some color other than standard color also can choose.

Available Types

○: allowable ×: non-allowable

CLOZA EXCEL	○
CLOZA LIGHT	○

Price

No additional charge

Upper Part Fabric for See-through Type

You can choose upper part see-through type on front and back Fabrics. While maintaining the care of elders and children, also keeping their privacies.

Allowable Size

Product Width (W)	550-5,000 mm
Product Height (H)	1,300-3,200 mm

*For ordering, round down the nearest 10 mm both in width and in height.

Available Fabric

Upper Part Fabric	TD-5011-5015
Lower Part Fabric	TD-5001-5010, 5016-5066

Part Color

It becomes the standard color of the lower part Fabric. Some color other than standard color also can choose.

Two Types

We have two types of upper see-through height. Please specify which height at the time of your order.



Upper part Fabric: TD-5013
Lower part Fabric: TD-5017

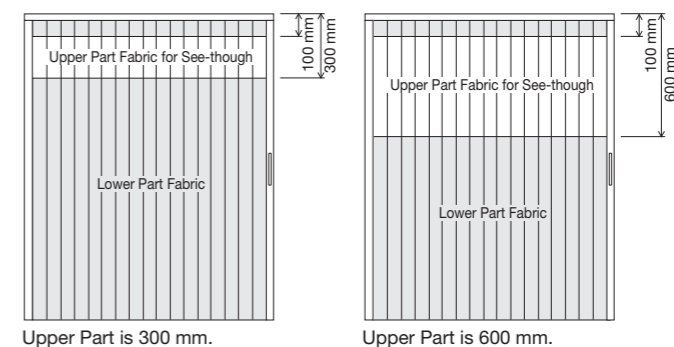

Upper Part is 300 mm.

Upper Part is 600 mm.

Available Types

○: allowable ×: non-allowable

CLOZA EXCEL	○
CLOZA LIGHT	×

Price

Standard price of lower part Fabric+15,900 Yen (tax excluded)

Inlay System Type

By inlaid the Track to the ceiling, hanging roots look neat.

*Inlay type requires a groove processing to the ceiling before installing the product.



CLOZA EXCEL

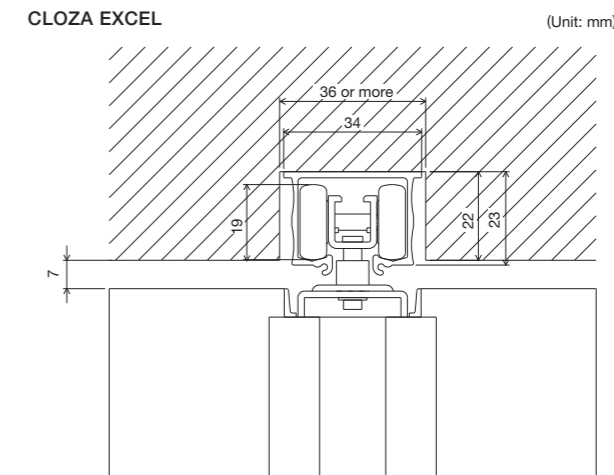

CLOZA LIGHT

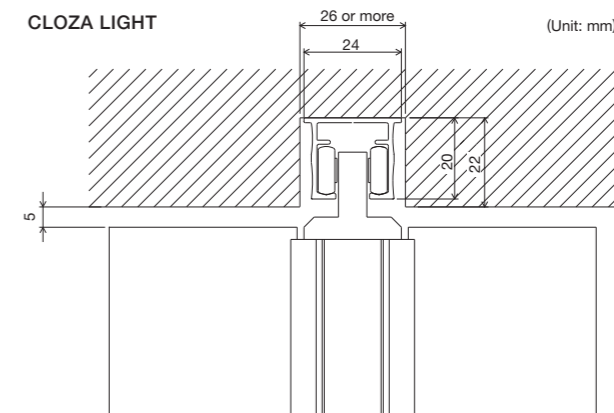

Available Types

○: allowable ×: non-allowable

CLOZA EXCEL	○
CLOZA LIGHT	○

Price

No additional charge

Lock System

Lock and unlock type by using the key. It is recommended to the location where you want to secure privacy such as your study or workplace.

*In the case of front and back different Fabric type, be sure to specify the Fabric product code of the keyhole side.



Keyhole side



Knob side

Keyhole, knob color: Silver

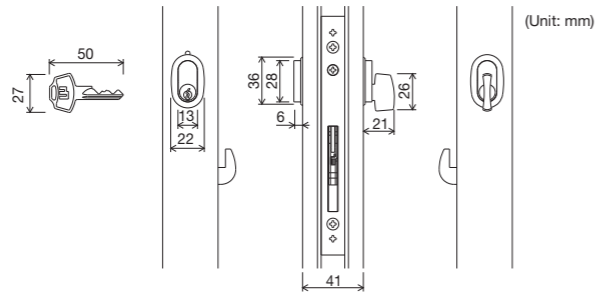

(Unit: mm)

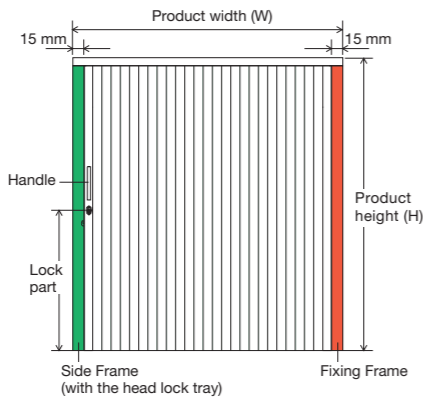

One-way draw

One-way draw, left lock

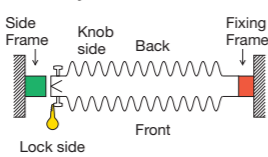

One-way draw, right lock

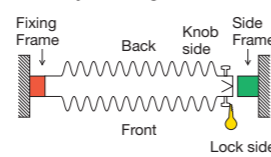

Use one-side Fixing Frame and one-side Side Frame, and attached the lock on the Side Frame side.

Available Types

○: allowable ×: non-allowable

CLOZA EXCEL	○
CLOZA LIGHT	×

Price

One-way draw

Standard price+24,700 Yen (tax excluded)
(with Side Frame: 1, Fixing Frame: 1, Key: 3)

Split draw

Standard price+25,400 Yen (tax excluded)
(with Fixing Frame: 2, Key: 3)

Product Height (H)	Lock Position	Product Height (H)	Lock Position
610-900	H - 375	2,410-2,500	H - 1,355
910-1,200	H - 575	2,510-2,600	H - 1,455
1,210-1,700	H - 655	2,610-2,700	H - 1,555
1,710-1,800	H - 755	2,710-2,800	H - 1,655
1,810-1,900	H - 855	2,810-2,900	H - 1,755
1,910-2,000	H - 955	2,910-3,000	H - 1,855
2,010-2,100	H - 1,055	3,010-3,100	H - 1,955
2,110-2,300	H - 1,155	3,110-3,200	H - 2,055
2,310-2,400	H - 1,255		

(Unit: mm)

Split draw

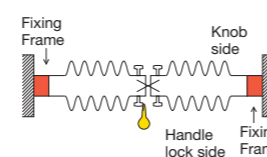

Use Fixing Frame on both sides.

Handle Lock System Type Antibacterial

It is possible to attach the Handle on both sides. If you want to open and close from every side of left or right, it is recommended.

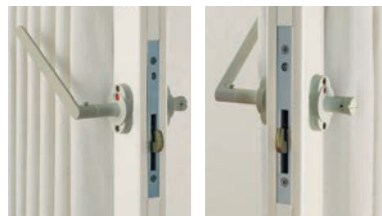

Keyhole side

Knob side



Locked

Unlocked

Keyhole, knob color: Platinum Gray

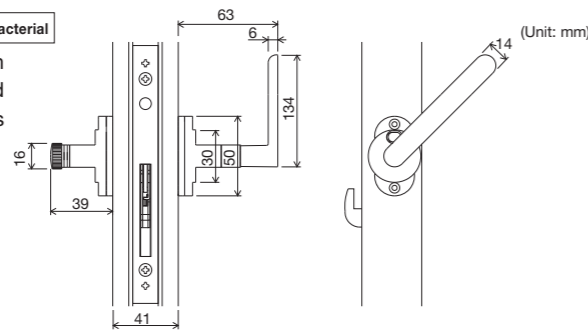

(Unit: mm)

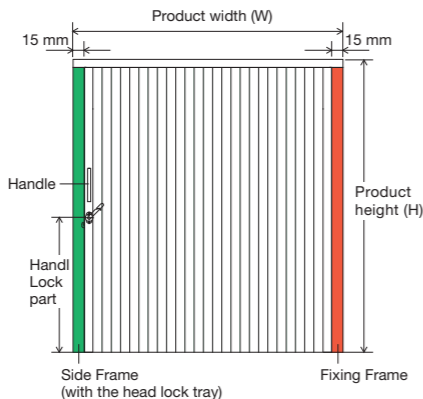

One-way draw

One-way draw, left Handle lock

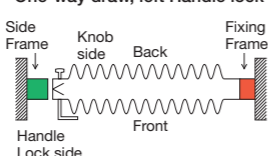

One-way draw, right Handle lock

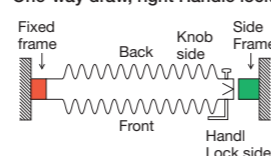

Use one-side Fixing Frame and one-side Side Frame, and attached the Handle lock on the Side Frame side.

Available Types

○: allowable ×: non-allowable

CLOZA EXCEL	○
CLOZA LIGHT	×

Price

One-way draw

Standard price+45,700 Yen (tax excluded)
(with Side Frame: 1, Fixing Frame: 1)

Split draw

Standard price+46,400 Yen (tax excluded)
(with Fixing Frame: 2)

Product Height (H)	Handle Lock Position	Product Height (H)	Handle Lock Position
610-900	H - 400	2,410-2,500	H - 1,380
910-1,200	H - 600	2,510-2,600	H - 1,480
1,210-1,700	H - 680	2,610-2,700	H - 1,580
1,710-1,800	H - 780	2,710-2,800	H - 1,680
1,810-1,900	H - 880	2,810-2,900	H - 1,780
1,910-2,000	H - 980	2,910-3,000	H - 1,880
2,010-2,100	H - 1,080	3,010-3,100	H - 1,980
2,110-2,300	H - 1,180	3,110-3,200	H - 2,080
2,310-2,400	H - 1,280		

(Unit: mm)

Split draw

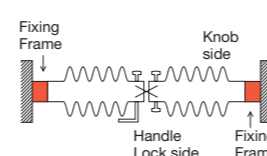

Use Fixing Frame on both sides.

Caution

In the case of front and back different Fabric type, please direct the front and back of the Fabrics, and the Handle lock position.

Curved Type

It is used as a partition to the corner in the storage space or dressing room.

Allowable Size

CLOZA EXCEL	Product Width (W)	550-4,500 mm
	Product Height (H)	610-3,200 mm
CLOZA LIGHT	Product Width (W)	600-3,000 mm
	Product Height (H)	1,610-2,400 mm
Curved Type	L-shaped Curve	450 mmR 800 mmR or more
	Overall Curve	800 mmR or more

*For ordering, round down the nearest 10 mm both in width and in height.

*Including the Tieback Hook and the Tieback (using the same Fabric).

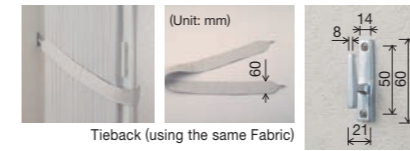

Tieback (using the same Fabric)

Tieback Hook Type F (Silver)

	Owo-way Draw	Split Draw
Tieback (using the same Fabric)	1	2
Tieback Hook Type F	2	4

L-shaped Curve



TD-5053

Overall Curve

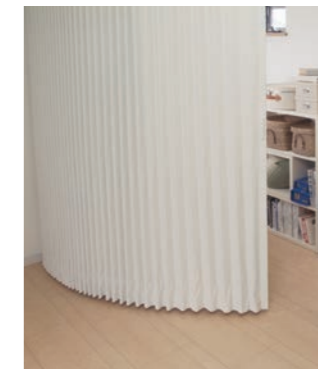

TD-5046

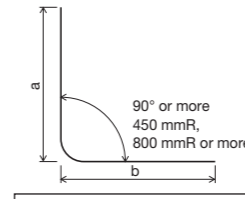

Product width = a + b
*Linear portions of "a" and "b" are 200 mm or more

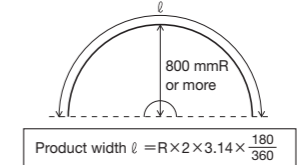

*Curved Track Length for Ordered Separately
CLOZA EXCEL: Maximum 4.5 m
CLOZA LIGHT: Maximum 4 m

Cut-out

Cut-out possible for the part of the product, if there are obstacles around at the top or bottom of the product installation location.

Upper Position Cut-out

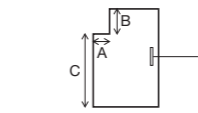

Allowable Size

A	70-450 mm
B	50-500 mm
C	1,200 mm-

Lower Position Cut-out

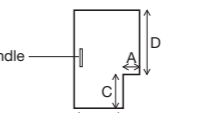

Allowable Size

A	70 mm-
B	400 mm-
C	50 mm-
D	500 mm-

Upper and Lower position Cut-out

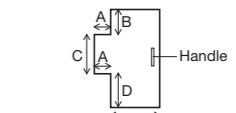

Allowable Size

A	70-450 mm
B	50-500 mm
C	1,200 mm-
D	B-
E	1,000 mm-

*For ordering of the cut-out, round down the nearest 10 mm both in width and in height.
*Cut-out part is the opposite of the handle.

Available Types

○: allowable ×: non-allowable

CLOZA EXCEL	○
CLOZA LIGHT	×

Price

Upper cut-out
Standard price+16,000 Yen (tax excluded)

Lower cut-out
Standard price+16,000 Yen (tax excluded)

Upper and Lower cut-out
Standard price+32,000 Yen (tax excluded)

Option Parts

Intermediate Stop

It is used in the case to fix the product in the middle of the Track, or to use as a mark at the center position of split draw.

CLOZA EXCEL



White

Platinum Gray

Dark Bronze

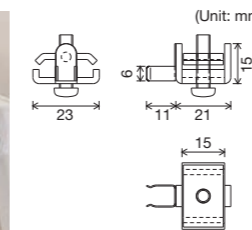

(Unit: mm)

CLOZA LIGHT



White

Platinum Gray

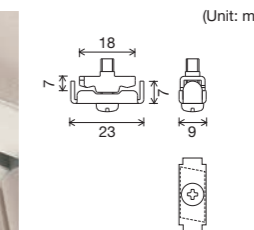

(Unit: mm)

Available Types

○: allowable ×: non-allowable

CLOZA EXCEL	○
CLOZA LIGHT	○

Price

CLOZA EXCEL
1 piece: 180 Yen (tax excluded)

CLOZA EXCEL
1 piece: 120 Yen (tax excluded)

*It takes delivery time if you order it separately.

■ End Cap

It is used when the end of the Track is not a wall, to prevent falling out the product.

CLOZA EXCEL

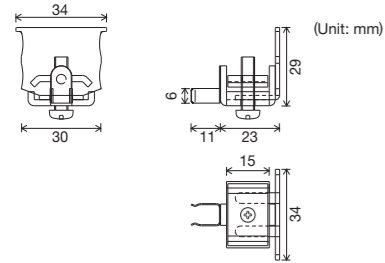

White Platinum Gray Dark Bronze

CLOZA LIGHT

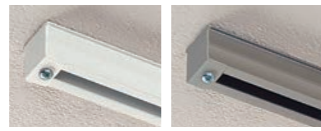
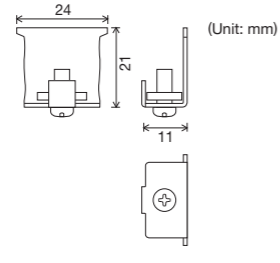

White Platinum Gray

Available Types

○ : allowable × : non-allowable

CLOZA EXCEL	○
CLOZA LIGHT	○

Price

CLOZA EXCEL
1 piece: 320 Yen
(tax excluded)

CLOZA LIGHT
1 piece: 180 Yen
(tax excluded)

*It takes delivery time if you order it separately.

■ Kamoi Bracket (for a Japanese sliding door)

Use to install the product on the lintel part.

CLOZA EXCEL



Product Width (mm)	Track	Number
550-1,200	1	3
1,210-1,650	1	4
1,660-2,400	1	5
2,410-3,300	1	7
3,310-4,000	1	9
4,010-4,500	1 (Optional)	9
	2 (Standard)	10
4,510-4,800	2	10
4,810-5,000	2	14



White Platinum Gray Dark Bronze

CLOZA LIGHT



Product Width (mm)	Number
600-1,000	3
1,010-1,750	4
1,760-2,250	5
2,260-2,750	7
2,760-3,000	9



White Platinum Gray

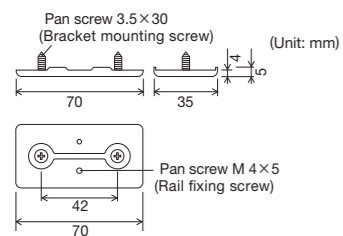

Available Types

○ : allowable × : non-allowable

CLOZA EXCEL	○
CLOZA LIGHT	○

Price

1 piece: 180 Yen
(tax excluded)

*It takes delivery time if you order it separately.

Attachment

Track Fixing Screw:
(pan M4 × 5) 1 piece
Bracket Screw:
(pan 3.5 × 30) 2 pieces

■ Side Frame

If the wall has a level difference because of the skirting board or crown molding, it fills a gap (thickness of skirt board, tec.) between the product and wall.

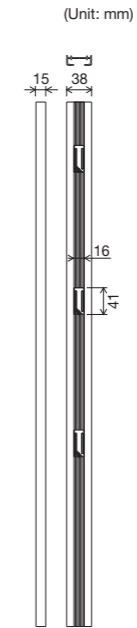

White



Platinum Gray



Dark Bronze

Available Types

○ : allowable × : non-allowable

CLOZA EXCEL	○
CLOZA LIGHT	×

Price

1 piece: 6,000 Yen
(tax excluded)

*It takes delivery time if you order it separately.

■ Wall Fitting

■ Wall Fitting

Use to fix one side of the product to the wall.

Product Height (mm)	Number
-2,200	2
2,210-	3

Available Types

○ : allowable × : non-allowable

CLOZA EXCEL	○
CLOZA LIGHT	○

Price

CLOZA EXCEL
1 piece: 310 Yen
(tax excluded)

CLOZA LIGHT
1 piece: 180 Yen
(tax excluded)

*It takes delivery time if you order it separately.

CLOZA EXCEL

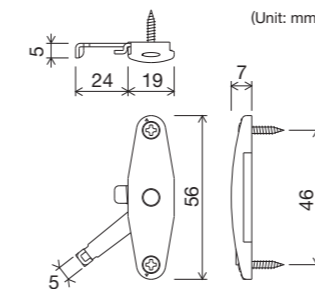

Mounting screws
(pan φ 3 × 16)

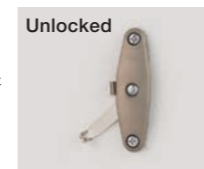
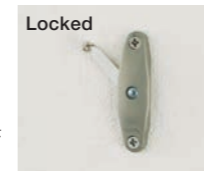

Platinum Gray

CLOZA LIGHT

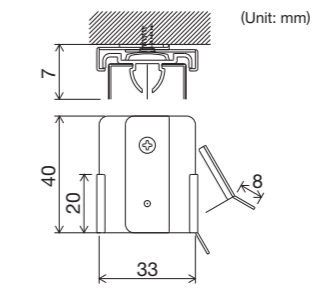

Mounting screws
(countersunk φ 3.1 × 16)

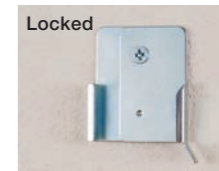

Silver

■ Fixing Frame

It is used if the wall has a level difference because of the skirting board or crown molding, and fixing one side of the product to the wall.



A fixed state

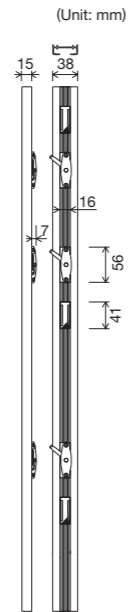

White



Platinum Gray



Dark Bronze

Available Types

○: allowable ×: non-allowable

CLOZA EXCEL	○
CLOZA LIGHT	×

Price

1 piece: 6,700 Yen
(tax excluded)

*It takes delivery time if you order it separately.

■ Overhead Hanger

On middle portion, it is a connecting part both the Track and Adjustable Hanger Rod. One place is necessary within a 500 mm interval.

Position of both ends: appropriate to locate them in a position 50–100 mm inward from each Track end.



CLOZA EXCEL



White



Platinum Gray



Dark Bronze

CLOZA LIGHT



White



Platinum Gray

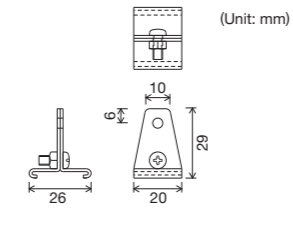
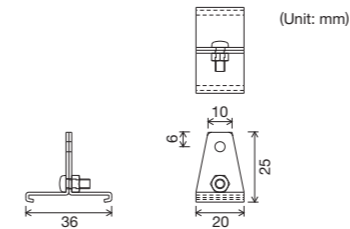

Available Types

○: allowable ×: non-allowable

CLOZA EXCEL	○
CLOZA LIGHT	○

Price

CLOZA EXCEL
1 piece: 140 Yen
(tax excluded)

CLOZA EXCEL
1 piece: 100 Yen
(tax excluded)

*It takes delivery time if you order it separately.

■ Adjustable Hanger Rod

Use to hang the product from the ceiling.

Two-hanging:

Use to support the Track in the middle hanging.

Three-hanging:

If the Track end can not be fixed to the wall, attach the Track with three-hanging to prevent rolling the Track.

One place is necessary within a 500 mm interval.

Position of both ends: appropriate to locate them in a position 50–100 mm inward from each Track end.

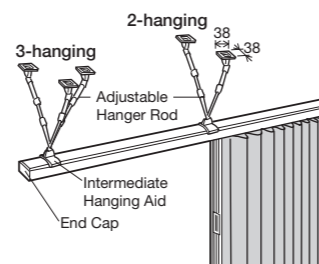

White

Umber

Available Types

○: allowable ×: non-allowable

CLOZA EXCEL	○
CLOZA LIGHT	○

Price

Adjustable Hanger Rod
B400 (250–400 mm)

1 piece: 1,110 Yen
(tax excluded)

Adjustable Hanger Rod
B700 (400–700 mm)

1 piece: 1,470 Yen
(tax excluded)

*It takes delivery time if you order it separately.

■ Wall Bracket

Use to fix the Track on the wall at middle portion.

CLOZA EXCEL

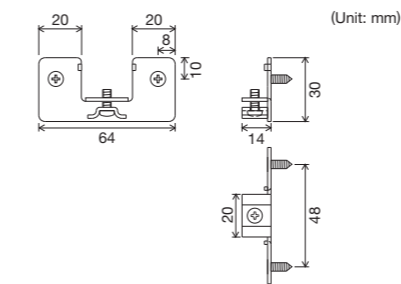

White



Platinum Gray



Dark Bronze

CLOZA LIGHT

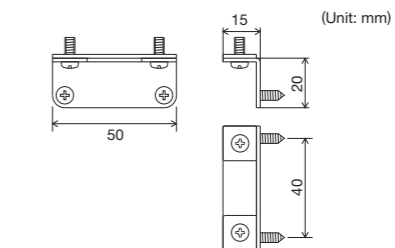

White



Platinum Gray

Available Types

○: allowable ×: non-allowable

CLOZA EXCEL	○
CLOZA LIGHT	○

Price

CLOZA EXCEL
1 piece: 140 Yen
(tax excluded)

CLOZA EXCEL
1 piece: 140 Yen
(tax excluded)

*It takes delivery time if you order it separately.

Maintenance Sticker

The purchasing product (custom-made product only) has been attached the maintenance sticker that describes the information about the product. See this maintenance sticker when inquiries and repair of the product.

Production date are described.

生産日: **, **, **

品名: CLOZA EXCEL

TD-**** 2000×2000

受注No: *****

Made in Japan

TOSO



Product specifications are described.

CLOZA EXCEL	TD-****	2000×	2000
Product name	Color code	Product width	Product height

CLOZA EXCEL

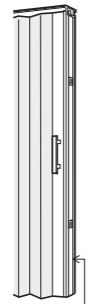

Pasted on the place where the frame cushion is removed

CLOZA LIGHT

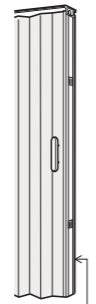

Pasted on the place where the frame cover is removed

How to Care

Wipe lightly with a cloth moistened with detergent if the product gets dirty.
Do not use the paint thinner.

How to Shorten the Height

● CLOZA EXCEL

Between 10 mm and 50 mm, available shorten the product height to the nearest 10 mm.

- Remove the main unit from the Track, and remove the Cap End at the bottom of the body.
- Remove the Frame Cushion, remove fixing screw, and remove the Frame Cover.
*Since Frame Holder remains to the Cut Frame side, take care not to lose it.
- Peel off the Fabric about 100–200 mm from the Cut Frame.

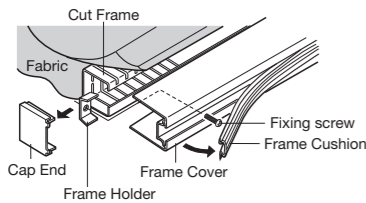

- Cut the Cut Frame in a length you want to shorten with a nipper, and cut out unnecessary part with folding several times. File the cut surface.

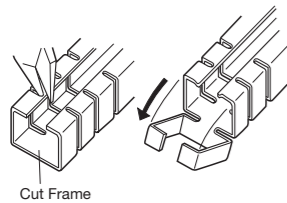

- Cut the Fabric leaving the turn-up margin (of 20–50 mm) to fit the Cut Frame. Undo the sewing thread as necessary.

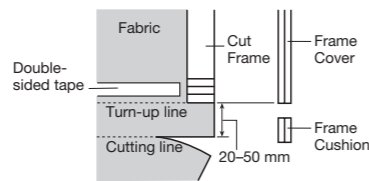

- Bond the Fabric with double-sided tape along the return line of the Fabric.
- Cut the Frame Cover and the Fabric Cushion with hacksaw to fit the Cut Frame.
- Paste the Fabric to the Cut Frame.

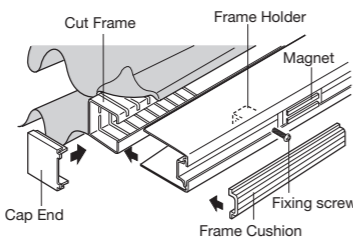

- Insert the magnet to the Frame Cover, and relocate to the original position.
- Do a temporarily tacking of the fixing screw and the Frame Holder to the Frame Cover.

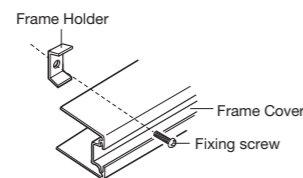

*Tacking of the fixing screw should be to the extent that Frame Cover and the Frame Holder hit as shown in the figure.

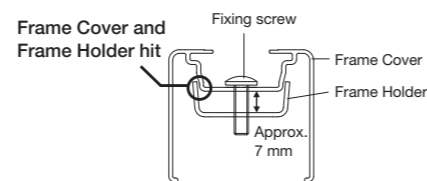

- Fit the Frame Cover to the Cut Frame, suit the position of the Handle, push strongly and fix it by tightening the fixing screw.
*Push the Frame Cover strongly and firmly.

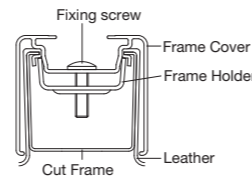

- Attach the Frame Cushion and the Cap End.
- Attach the main unit to the Track.
*If the slack of the Fabric has occurred, adjust the Fabric by pulling the tension tape to the bottom. If the tape is visible from the bottom of Fabric, cut the tape.

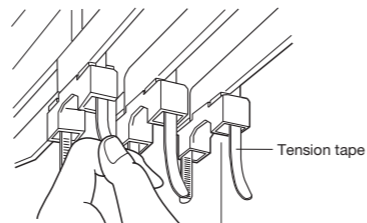

● CLOZA LIGHT

Available shorten the product height to the nearest 10 mm in the following range. (Unit: mm)

Product height (Two digits)	-0	-10	-20	-30	-40	-50	-60	-70	-80	-90
Allowable shortening length	90	00 (60)	10 (70)	20 (80)	30 (90)	40	50	60	70	80

- Remove the main unit from the Track, and remove the Cap End at the bottom of the body.
- Remove the Cap End and the Frame Cover at the bottom of the body.
- Peel off Fabric about 100–200 mm from Cut Frame.

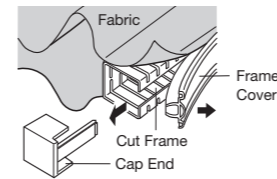

- Cut the Cut Frame in a length you want to shorten with nipper, and cut out unnecessary part with folding several times. File the cut surface.

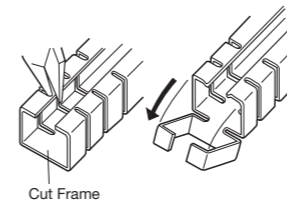

- Cut the Fabric leaving the turn-up margin (of 20–50 mm) to fit the Cut Frame. Undo the sewing thread as necessary.

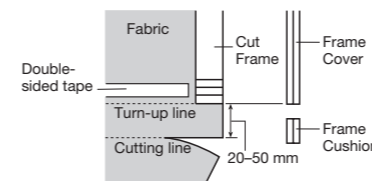

- Bond the Fabric with double-sided tape along the return line of Fabric.
- Cut the Frame Cover and the Frame Cushion with hacksaw to fit the Cut Frame.
- Paste the Fabric to the Cut Frame.
- Push strongly the Frame Cover to the Cut Frame, and attach the Cap End.
- Attach the main unit to the Track.

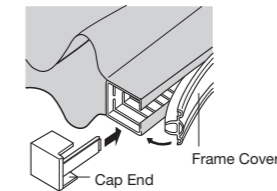

*If the slack of the Fabric has occurred, adjust the Fabric by pulling the tension tape to the bottom. If the tape is visible from the bottom of Fabric, cut the tape.

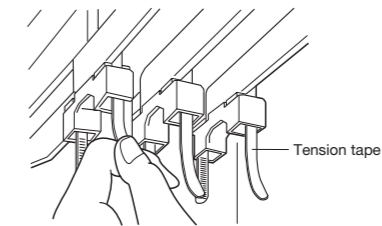

How to Order

1 Choose your type of Accordion Doors. e.g.) CLOZA EXCEL

2 Specify your number of Fabric. e.g.) TD-5001

*In general, we choose standard color of each Fabric, if not specified.
Specify your color if you want to change.

3 Specify optional specs if necessary.

Available Types Table ○: allowable ×: non-allowable

Product Name	CLOZA EXCEL	CLOZA LIGHT	Note
Optional Specs			
Long Handle type	○	×	_____
Both Handle type	○	○	_____
Front and back different Fabric type	○	○	Specify the Fabric number of each the front and back surface. The surface which the Handle position becomes on the right is the front surface.
Upper part Fabric for see-through	○	×	Specify the Fabric number of each the upper and lower part, and specify either the upper part size of 300 mm or of 600 mm.
Inlay system type	○	○	_____
Lock system type	○	×	Specify the Fabric of the front and back, and specify the keyhole side.
Handle lock system type	○	×	Specify the Fabric of the front and back, and specify the Handle lock side.
Curved type	○	○	Specify the curve type, radius, and angle.
Cut-out	○	×	Specify the cut out type and the cut out dimensions.

4 Select from the following: one-way draw and split draw. e.g.) One-way Draw

5 Specify the dimensions (width and height). e.g.) Width: 2,000 mm, height: 2,000 mm

*CLOZA EXCEL, CLOZA LIGHT:
For the product dimensions, specify to round down the nearest **10 mm** on the one-way draw.
For split draw, 2 units of one-way draw size.
Specify your Track size if you need one of connected Tracks.

6 Specify the quantity. e.g.) 1 set

7 Specify optional parts quantity if necessary.

Available Types Table ○: allowable ×: non-allowable

Product Name	CLOZA EXCEL	CLOZA LIGHT	Note
Optional Parts			
Intermediate Stop	○	○	Specify your color.
End Cap	○	○	Specify your color.
Kamoi Bracket (for a Japanese Sliding door)	○	○	Specify your color.
Side Frame	○	×	Specify your color and product height.
Wall Fitting	○	○	_____
Fixing Frame	○	×	Specify your color and product height.
Adjustable Hanger Rod	○	○	Specify the hanger rod size.
Overhead Hanger	○	○	Specify your color.
Wall Bracket	○	○	Specify your color.

Order Form

Product Name	<input type="checkbox"/> CLOZA EXCEL <input type="checkbox"/> CLOZA LIGHT				
Fabric Number	TD-				
Optional Parts	<input type="checkbox"/> Long Handle type <input type="checkbox"/> Both Handle type <input type="checkbox"/> Front and back different Fabric type <input type="checkbox"/> Upper part Fabric for see-through type <input type="checkbox"/> Inlay system type <input type="checkbox"/> Lock system type <input type="checkbox"/> Handle lock system type <input type="checkbox"/> Curved type <input type="checkbox"/> Cut-out				
One-way Draw Split Draw	<input type="checkbox"/> One-way draw <input type="checkbox"/> Split draw				
Product Dimensions (Width × Height)		mm	×	mm	
Quantity					Set(s)
Optional Parts	<input type="checkbox"/> Intermediate Stop <input type="checkbox"/> End Cap <input type="checkbox"/> Kamoi Bracket (for Japanese Sliding door) <input type="checkbox"/> Side Frame <input type="checkbox"/> Wall Fitting <input type="checkbox"/> Fixing Frame <input type="checkbox"/> Adjustable Hanger Rod <input type="checkbox"/> Overhead Hanger <input type="checkbox"/> Wall Bracket				