

New Delac



- Multi-purpose rail with a wide range of applications.
- Manual, cord draw and motor operation are possible.
- Exceptional durability satisfying the strict demands of a 10,000 open/close test.
- Can also be used as a hospital partition rail, IV rail and picture rail.
- It can be used for wavy styles that bring out the natural texture of the fabric.

New Delac

New Delac's Unique Features and Applications

Using the Overlap MG Carrier for Hand provides better light shielding.

The Overlap MG Carrier effectively prevents unwanted light from streaming into a room. Light is kept out even where the curtains overlap in the middle. And the rollers run very smoothly.

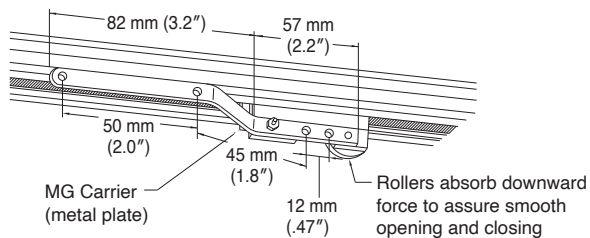

*Perfect light shielding may not be possible depending on the type of window and installation method. Please consult a specialist when designing window covering for a darkroom or photo lab.

Use an IV Roller for an IV Rail.

New Delac's exceptional durability and safety make it ideal for use as an IV Rail in hospitals and other medical institutions. The IV Rollers are also designed to lock under the weight of an IV bottle. And the wheel parts are made of a special resin to effectively reduce sliding noise.

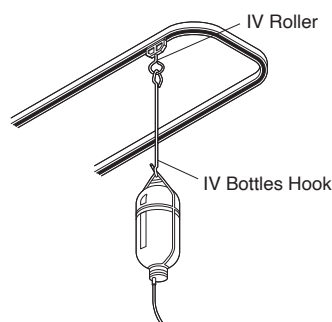

Smart Wave Curtain System

[Invisible Pitch Keeper Tape]

By connecting the roller and the pitch keeper tape, it can create a beautiful curtain wave. The pitch keeper tape fits inside the track for a clean look.

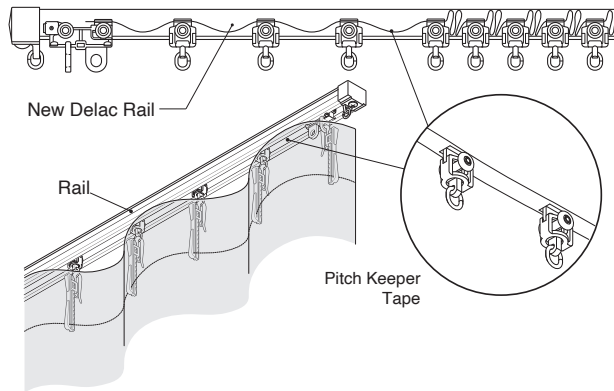

Wave Style

[Pleating Cord Type]

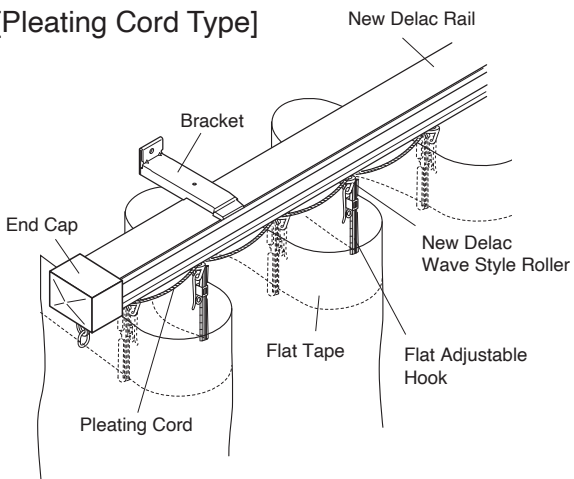

- The Wave Style creates a feeling of naturally flowing fabric.
- The curtains are draped in gentle waves about 1.5–2.2 times the width of window, resulting in a continuity of pattern and texture.
- There is a natural wave in the curtains at intervals of 80 mm (3.2").
- With its tape and accessories, it creates natural, elegant symmetrical waves.

*Pleating cord keeps waves evenly shaped, making the curtain rich and stylish.

*For more details about Wave Style, please refer to the catalog "New Delac with Wave Style Components".

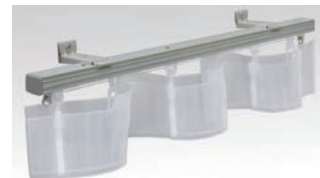

NT Bracket convenient when there is insufficient vertical space for installation.

This bracket is convenient when there is insufficient vertical space for bracket installation. It is firmly secured with just two screws.

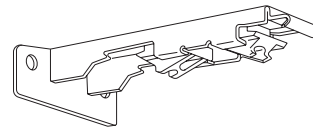

Brackets with a temporary hook makes installation easier.

(Excluding Extra Brackets)

This bracket holds a rail while allowing you to adjust a rail position. Once you finish adjusting a position, simply snap the rail into the bracket to secure firmly.

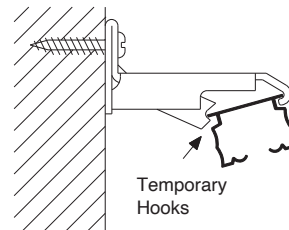

Smooth opening and closing with separate grooves for rollers and traverse cord.

Installation is easy and the cord is located in a groove to prevent it from becoming entangled with the rollers. The smooth-running rollers also assure easy opening and closing.

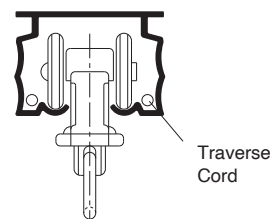

Partitioning is flexible, by using the Last-in Intermediate Stop

Last-in Intermediate Stop is usable both fix and open/close the curtain.

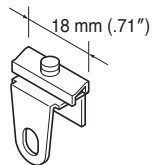

Last-in Intermediate Stop

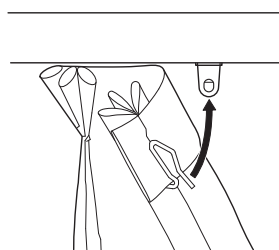

Curtain hook is fixed by turning the hole toward the front.

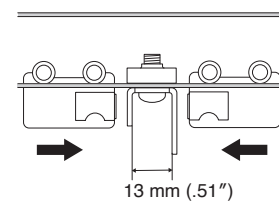

When the hole is turned sideways, MG Carrier can be attracted.

Can also be used with a Curtain Motor. (Powerful Series)

Exceptionally convenient for opening and closing wide curtains, curtains installed in a high location, and heavy curtains.



New Delac

New Delac Rails

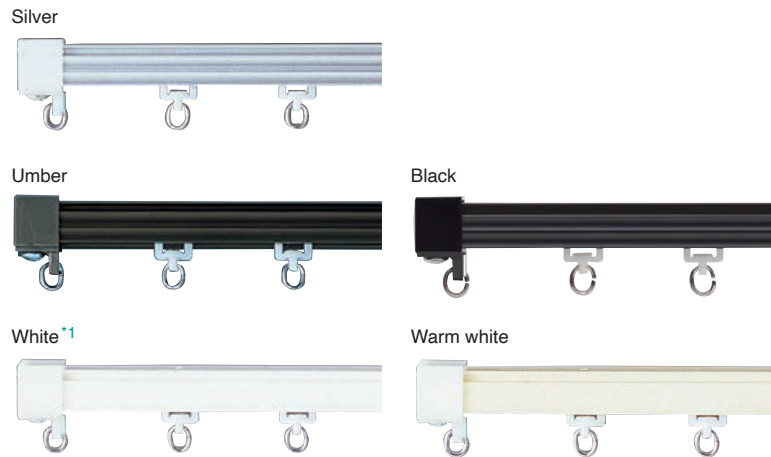
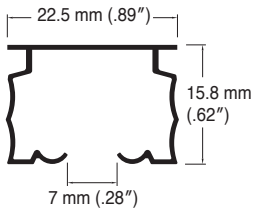

Size	Product Code					
	Silver	Umber	Black	White *1	Warm white	
1.82 m (72")	00210120	00210036	30010561	————	00210226	
2.00 m (79")	00210121	00210038	30010562	————	00210227	
2.73 m (107")	00210122	00210039	30010563	————	00210228	
3.00 m (118")	00210123	00210040	30010564	————	00210229	
3.64 m (143")	00210124	00210047	————	————	00210230	
4.00 m (157")	00210125	00210048	————	————	00210231	
Curved Rail (180 mmR / 7.1"R)	0.40 m x 0.40 m (16" x 16")	00210126	00210045	30010565	————	00210232
	1.00 m x 1.00 m (39" x 39")	00210035	00210046	30010566	————	00210233
Overlap Rail 0.50 m (20")	00210208	00210043	30010567	————	00210234	

*1 For the White, please inquire of TOSO.

Materials and Finishes

Parts	Material	Finish
Rail	Aluminum alloy extrusion material	Alumite
		Alumite umber
		Alumite black
		Alumite white
		Alumite warm white

Parts	Material	Finish
Roller	Plate	Hard polyethylene
	Wheel	Hard polyethylene
	Oval ring	Stainless steel
End Cap	Body	Nylon
	Oval ring	Stainless steel
Bracket	Body	Steel
	Hook	Acetal resin

Bracket Installation Interval and Allowable Curtain Load

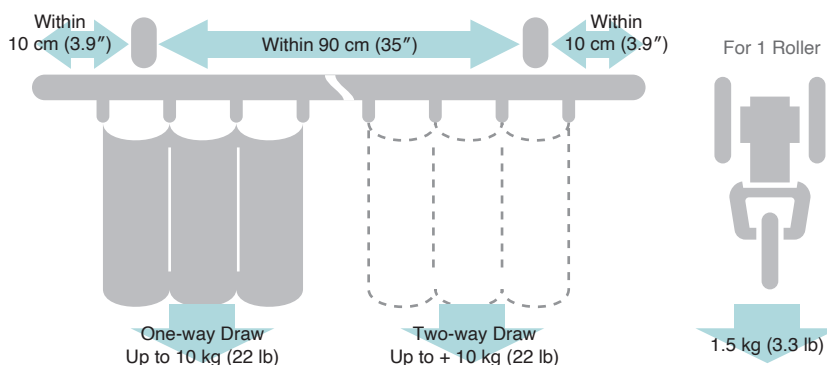

Installation Dimensions

Ceiling Attachment

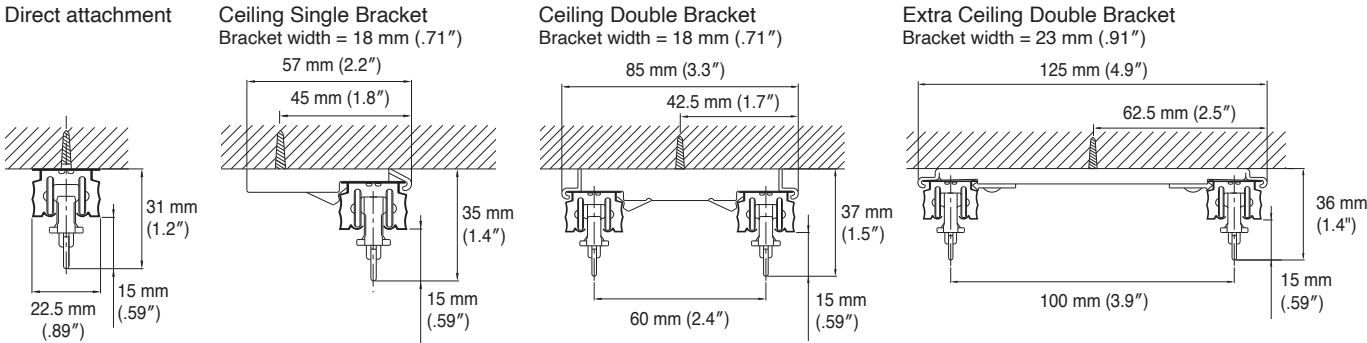



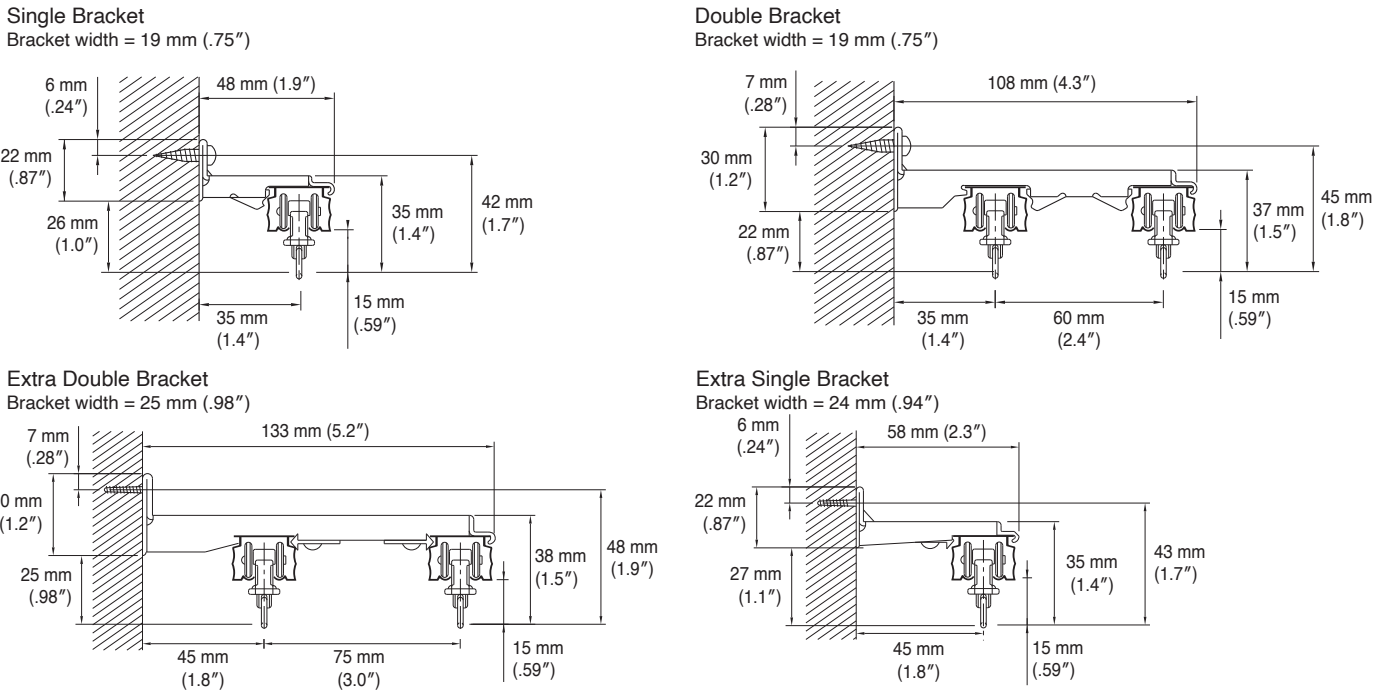



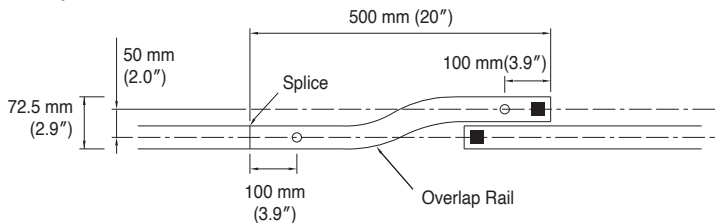



Wall Attachment





Overlap Rail

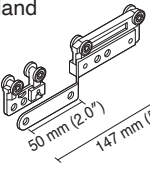





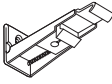
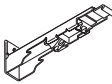
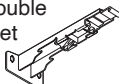
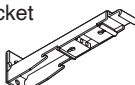
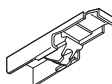
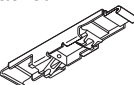
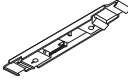

New Delac Parts



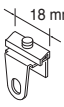



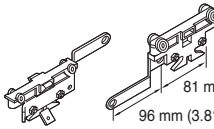
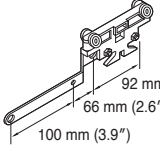
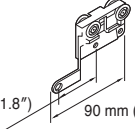

Product Name		Product Code
Roller (8 pieces per strip)		Natural 00210027
MG Carrier		Natural 00210054
One-way MG Carrier		Natural 00210053
NN Roller (for last-in)		00210008
Noiseless Roller (8 pieces per strip)		Natural 00210188
Noiseless MG Carrier		Natural 00210189
Noiseless One-way MG Carrier		Natural 00210190
Soundproof Packing Silence effect improves together it with Noiseless Roller.		00210023
Overlap MG Carrier for Hand	 50 mm (2.0") 147 mm (5.8")	00210006
Carabiner Roller		Natural 30018426

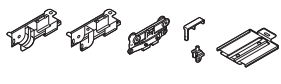
*1 For a curved rail, use with a rail with a radius of 240 mm (9.4") or more. A rail with a 180 mm (7.1") radius can not be used.

Product Name		Product Code
Single Bracket		Silver 00210213
		Umber 00210214
		Black 30010574
		White 00210324
		Warm white 00210215
Extra Single Bracket		Silver 00210012
		Umber 00210084
		White 30011802
		Warm white 00210155
Double Bracket		Silver 00210216
		Umber 00210217
		Black 30010575
		White 00210325
		Warm white 00210218
NT Double Bracket		Silver 00210222
		Umber 00210223
		Warm white 00210224
Extra Double Bracket		Silver 00210109
		Umber 00210082
		White 30011801
		Warm white 00210157
Ceiling Single Bracket		Silver 00210191
		Umber 00210192
		Black 30010576
		White 00210326
		Warm white 00210193
Ceiling Double Bracket		Silver 00210219
		Umber 00210220
		Black 30010577
		White 00210327
		Warm white 00210221
Extra Ceiling Double Bracket		Silver 00210107
		Umber 00210196
		White 00210353
		Warm white 00210197
Overhead Hanger		Silver 00210105
		Umber 00210198
		White 30010578
		Warm white 00210199
Wall Bracket		Silver 00210015
		Umber 00210201
		Black 30010579
		White 00210331
		Warm white 00210202

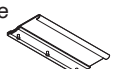
Product Name		Product Code
End Cap		Natural 00210010
		Umber 00210086
		Black 30010572
End Stop B		Natural 00210135
		Umber 00210137
		Black 30010573
		White 30011800
Last-in Intermediate Stop		18 mm (.71") 30009046
		00210134
Intermediate Stop		00530063
Return Aids for End Stop		00530063
Pulley Set		Silver 00210002
		Umber 00210081
		White 00210333
		Warm white 00210159
Master Roller		81 mm (3.2") 96 mm (3.8") 00210262
		00210264
Long Master Roller		92 mm (3.6") 66 mm (2.6") 100 mm (3.9") 00210264
One-way Master Roller		45 mm (1.8") 90 mm (3.5") 00210001

New Delac Parts

Product Name		Product Code		
Cord Draw Parts	Overlap Cording Parts Kit  (*1)	00210225		
	Traverse Cord 2.8 mm DIA.	White	00580009	
	Tension Pulley 240 	White	00500005	
		Brown	00500002	
Tension Pulley 450 	Silver	00500007		
Other Parts	Splice for Aluminum Rail 	00210128		
	OT Splice 	Silver	00210024	
		White	00210323	
Other Parts	Adjustable Hanger Rod A 	A170 (130-170 mm/ 5.1-6.7")	Silver	00290034
			White	00290038
			Black	30018783
		A250 (170-250 mm/ 6.7-9.8")	Silver	00290036
			White	00290039
			Black	30018782
		A400 (245-400 mm/ 9.6-16")	Silver	00290017
			White	00290040
			Black	30018781
		A700 (395-700 mm/ 16-28")	Silver	00290016
			White	00290041
			Black	30018797
		A1100 (595-1,100 mm/ 23-43")	Silver	00290015
			White	00290042
		Black	30018789	
	A1600 (845-1,600 mm/ 33-63")	Silver	00290014	
		White	00290043	
		Black	30018786	
Adjustable Hanger Rod B 	B400 (250-400 mm/ 9.8-16")	Umber	00290013	
		White	00290026	
	B700 (400-700 mm/ 16-28")	Umber	00290012	
		White	00290025	
IV Roller 	00210052			
Allowable load 10 kg (22 lb)				



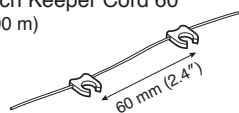
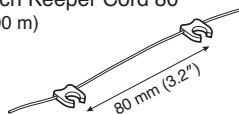

Wave Style Dedicated Parts (Cord Type)

Product Name	Product Code
New Delac Wave Roller (2,000 pcs) 	30019113

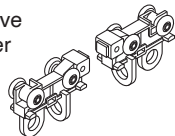
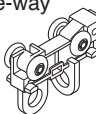
Product Name	Product Code
New Delac Pitch Keeper Cord 60 (200 m) 	30019114
New Delac Pitch Keeper Cord 80 (200 m) 	30019115

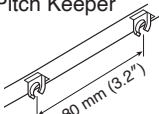
Smart Wave Curtain System Dedicated Parts

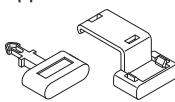
Product Name	Product Code
Smart Wave Roller 	30018621
Smart Wave MG Carrier 	30018622
Smart Wave One-way MG Carrier 	30018623

Product Name	Product Code	
Invisible Pitch Keeper Tape 80 (15 m) 	30018624	
Invisible Pitch Keeper Tape 80 (50 m) 	30018625	
Curtain Stopper 	30018807	
Wave End Cap 	Natural	30018808
	Black	30018809
	Umber	30018810

*1 Contents of Kit: Overlap Pulley Set (1 set), Pilot Roller (2 pcs), Overlap Bracket (1 pc), Intermediate Stop (4 pcs), Cord Clip (10 pcs)

Curtain Wand

To keep the Wave Style, the New Delac is available with a Curtain Wand that attaches to the leading MG Slider. It is easy to operate high curtains and thick/heavy curtains, and prevents stains and wrinkles because the curtain fabric is not directly touched.

Curtain Wand / White (steel)

SIAA ISO 21702 Anti Virus
Inorganic antiviral processing agent /printed
Grip JP0612873X0004M

SIAA ISO 22196 Anti Bacteria
Inorganic synthetic antibacterial finishing agent /printed
Grip JP0122873X0004I

54 mm (2.1")
450 mm (18")
700 mm (27")
900 mm (35")
1,200 mm (47")
1,500 mm (59")

φ8 mm (3.1")
80 mm (3.1")
φ17 mm (6.7")

Anti-virus and anti-bacterial processing

Materials	steel
-----------	-------

Curtain Wand Product Code		
White	450 mm	30018973
	700 mm	30018974
	900 mm	30018975
	1,200 mm	30018976
	1,500 mm	30018977

Curtain Wand / Crear (resin)

SIAA ISO 21702 Anti Virus
Inorganic synthetic antiviral processing agent /printed
Bottom of pole JP0612873X0005N

SIAA ISO 22196 Anti Bacteria
Inorganic synthetic antibacterial finishing agent /printed
Bottom of pole JP0122873X0005I

54 mm (2.1")
450 mm (18")
700 mm (27")
900 mm (35")

φ10 mm (3.9")
130 mm (5.1")
10 mm (3.9")

Anti-virus and anti-bacterial processing

Materials	resin
-----------	-------

Curtain Wand Product Code		
Clear	450 mm	30018978
	700 mm	30018979
	900 mm	30018980

Curtain Wand White and Clear are SIAA safety standards compliant for antiviral performance. It reduces the number of specific viruses on the product.

The SIAA mark is displayed on products that have been evaluated according to the ISO 21702 and ISO 22196 methods, and whose quality control and information have been disclosed under the Antimicrobial Product Technology Council guidelines.

Anti-virus processing

- This product is not a pharmaceutical product.
- It uses antiviral materials that meet the safety standards of SIAA.
- This product conforms to SIAA safety standards.
- Antiviral processing is not intended to treat or prevent diseases.

Antibacterial processing

- This product is not a pharmaceutical product.
- It does not inhibit the growth of all bacteria.
- This product uses antimicrobial materials that meet SIAA safety standards.

Curtain Wand / Gray (rope type)

54 mm (2.1")
700 mm (27")
900 mm (35")

φ5 mm (2.0")
100 mm (3.9")
φ20 mm (7.9")

Materials	700	900
rayon	58 %	57 %
cotton	37 %	39 %
polyester	5 %	4 %

Curtain Wand Product Code		
Gray	700 mm	30018981
	900 mm	30018982

How to Use the Curtain Wand



Photo is the White (steel).

How to Install

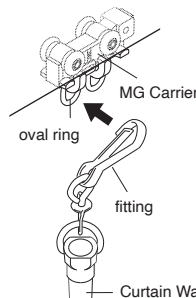

Hook the fittings of the Curtain Wand to the oval ring of the MG Carrier.

*If the MG Carrier has two oval rings, hook the Curtain-hook to the first oval ring and the fittings of the Curtain Wand to the second oval ring.

Approximate Curtain Wand Length

Rail height position	2,200 - 2,400 mm	2,000 - 2,200 mm
Wand length	900 mm	700 mm

*In case used by a person with a height of 155 cm