

TOSO

Vertical Blind

DUAL 100

No.V-08101001

Instruction Manual

Thank you for purchasing TOSO products. To ensure safe use of this product, please read the following thoroughly and keep this manual stored.

Guide for Distributors and Installation Contractors

This manual contains information for a user to safely operate this product.
Please provide this manual to a customer.

INDEX

■ Cautions	2
■ Product View and Part Names	4
■ Installation and Detaching.....	5
■ Operation Methods	11
■ Maintenance Sticker.....	13
■ Cleaning	13
■ Product Warranty Certificate.....	14

CAUTIONS

* This manual contains cautions and instructions for safe use of the product. Please read it carefully before using to ensure appropriate use.

● This document illustrates the dangers of using this product without taking necessary precautions. Please refer to the symbols below for different types of safety points.

 **Warning** Illustrates that if this product is misused, there are dangers of serious injuries or possible fatal accidents.

 **Caution** Illustrates that if this product is misused, there are dangers of casualties or possible physical damage of the product.



● This document illustrates safety points to be followed using the symbols below.

 Illustrates specific actions which are prohibited.



 Illustrates specific guidelines which must be followed.

■ Precautions upon installing the product (Please read before installation.)

 **Warning**

-  Screws provided are for xylem only. Do not use on materials other than xylem.
-  Check the foundation base and strength of the material before installing this product. If not installed properly to the foundation base, there are dangers of it falling.
-  Install this product as instructed with the necessary quantity of brackets. Otherwise the product may fall.





 **Caution**

-  This product is intended for indoor use. Please do not use it for outdoor purposes.
-  Locations subject to high temperatures and high humidity, or areas where water may leak, should be avoided.
-  Make sure to install this product horizontally.



■ Safety During Use (Please read thoroughly)

 **Warning**

-  Please keep the cord or the chain where children cannot reach.
-  Please avoid actions which may result in the cord or the chain entangling the body or becoming hooked onto something. This may cause an accident.
-  When not in use, please take the cord and put away the handling cord by wrapping it around the safety hook.
-  Please do not hang from or pull on this product. This may damage the product or cause it to fall down.



Japan Blind Industry Association

-  Please do not operate the product with sudden or forceful motion. This may damage the product or cause it to fall down.



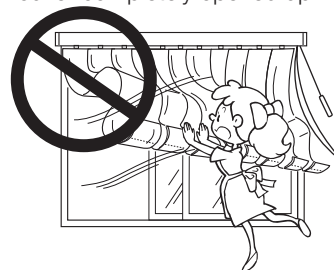

 **Caution**

-  When there is strong wind, please either close the window or have the louver completely opened up.
-  Please do not dismantle the mechanical assembly or lubricate the moving parts of this product. Physical damage or malfunction of the product will occur.



-  Please do not use this product around open flames.

-  Please remember to always use the drive cord or Operation Wand when operating this product. Please do not attempt to move the louver directly.
-  Please do not place any fragile objects or objects that may interfere with operation near the Louver.



Product View and Part Names

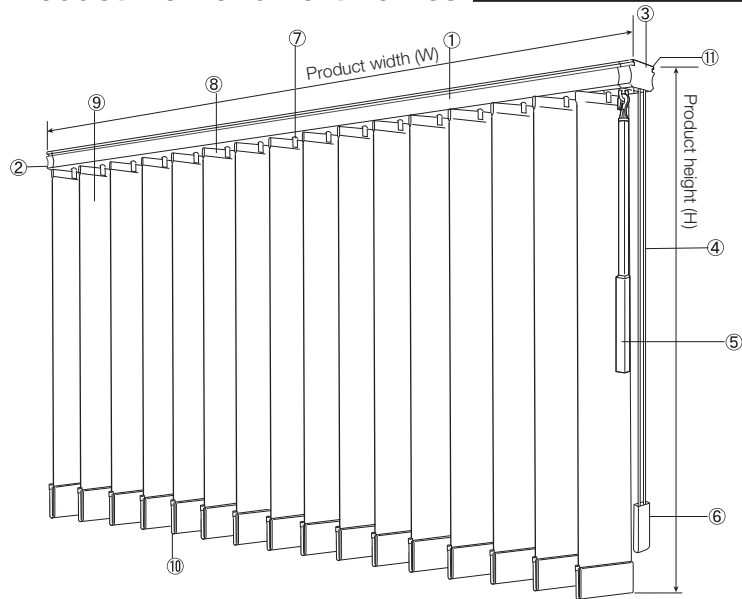

Product Name

- ① Head Rail
- ② Side Cap
- ③ Cord side Cap
- ④ Drive Cord (outside)
- ⑤ Operation Wand (inside)
- ⑥ Tension Weight
- ⑦ Roller Hook
- ⑧ Hanger
- ⑨ Louver
- ⑩ Balance Weight
- ⑪ Maintenance Sticker

Components Parts

Components Name	Bracket (*)		Fixing Screw (*)	Safety Tassel
	Product Width (mm)			
300-1200	Ceiling Bracket	L-Shape Bracket + Screw (for Front Attachment)	Fixing Screw (round head Ø3.5 x 20)	1
1210-2400	2	3	3 (9)	
2410-4000	4	4	4 (12)	

* The number in parentheses is for installation type of Front Attachment.

* The bracket attachment details vary depending on the specifications for the requested product. For Ceiling Attachment products, Ceiling Bracket are included. For Front Attachment, Ceiling Bracket and L-Shape Bracket (for Front Attachment) + attachment screws are included. For installing methods, see "Installing the Brackets" on P.6.

Option components

Bottom Cord



Product Weight

3.9kg (Product Width 2,000 mm x Product Height 2,000 mm)

Installation and Detaching

Caution

- ⚠ Screws provided are for xylem only. Do not use on materials other than xylem.

Installation Method <Ceiling Attachment>

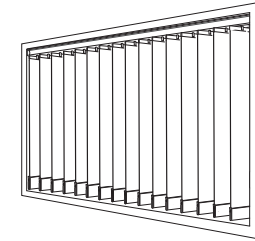

<Front Attachment>

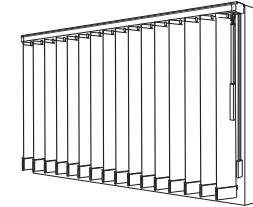

Installation Dimension (mm)

* Product Height: From the attaching surface of the Head Rail to the bottom end of the Louver (not included the thickness of Bracket)

Ceiling Attachment (with Ceiling Bracket)

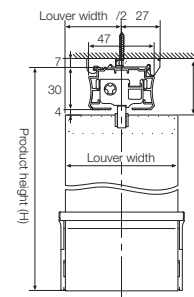

Front Attachment (with L-Shape Bracket)

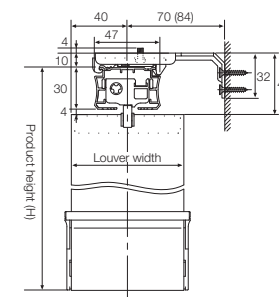

■ Bracket Position

- Install the Bracket in a position 40-60mm from the edge of the Head Rail and avoid the resin parts. If there are three or more Brackets, be sure to install them at intervals that are as equally spaced as possible.

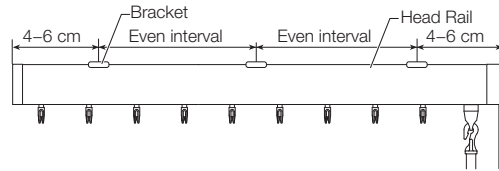

■ Installing the Brackets

- Follow the illustrations for "Installation Dimension" on p.5 and use the included Fixing Screws to install the Brackets.

For Ceiling Attachment
(There is one fixing screw for each bracket.)

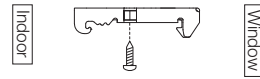

For Front Attachment
(There are three fixing screws for each bracket.)

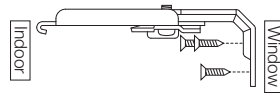

- * For Front Attachment, please use the Ceiling Brackets in combination with the L-Shape Brackets. There are two mounting holes on the Ceiling Brackets. By using either hole, you can adjust the protrusion width during installation.

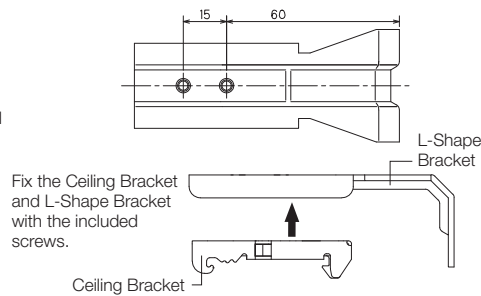

■ Installing the Head Rail

<For Front Attachment>

- 1 Latch the temporary stopper hook onto the Head Rail.
- 2 Push the Head Rail in until it clicks into place.

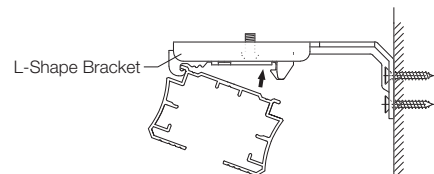

⚠ Caution

- ❗ After installing the Head Rail, make sure the Head Rail is secured to the brackets.

■ Installing the Operation Wand

- Latch the hook on the Operation Wand onto the ring on the Head Rail.
- * If the installing height is 4010mm or higher, the Operation Wand will be jointed. After attaching the gripless Wand to the Head Rail, latch the gripped Wand onto the joint.

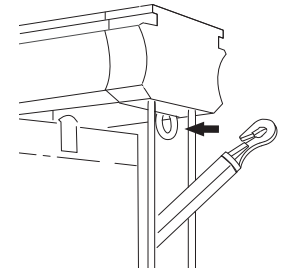

■ Installing the Louver

- 1 Operate the Drive Cord to align the hooks on either side. Align both sides simultaneously for the double-leaf type.
- * Simply reverse the illustration if you plan to install the cords on the left-hand side.
- * If the installing height is 3010mm or higher, the Operation Wand will be fixed on the operation side.

<Right-side alignment>
(Left side open)

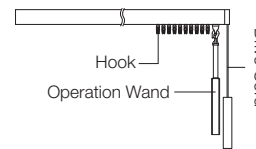

<Left-side alignment>
(Right side open)

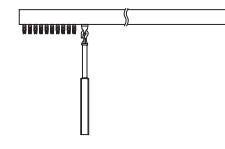

<Double-leaf>
(Center open)

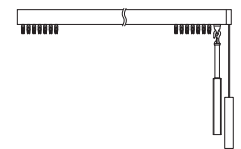

- 2 Turn the Operation Wand to position the hooks perpendicular to the Head Rail.

- * Louvers may not rotate properly unless they are fitted with Roller Hooks in the perpendicular position.

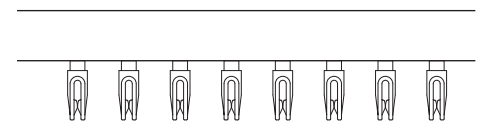

- 3 Arrange the Louvers to be all face in the same direction and attach the matching part (i.e., hanger) of the louver mount to the corresponding Roller Hook.

<In the case of heat plate welding specification>

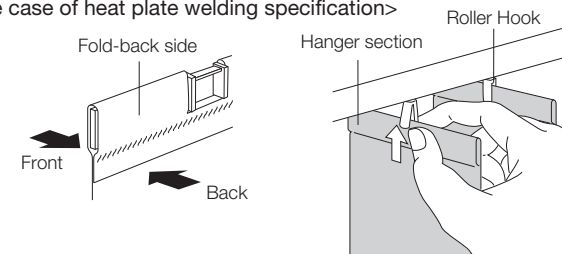

■ Installing the Bottom Cord (Optional)

<For Roll-Type>

- 1 Turn the Operation Wand and adjust the Louver to be perpendicular to the Head Rail. From above, insert the Bottom Cord connector into the protrusions on each side of each Balance Weight.

* When attaching, be sure to start with the closest Balance Weight and Bottom Cord.

* Be careful that the Bottom Cord does not become twisted.

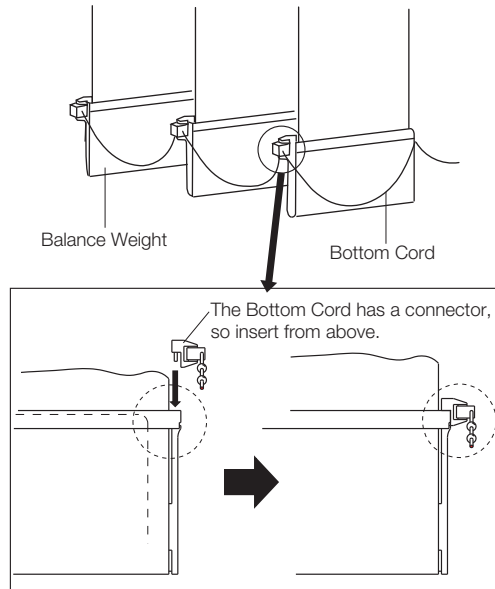

- 2 Thread the Bottom Cord through the Balance Weights of all Louvers and cut excess Bottom Cord.

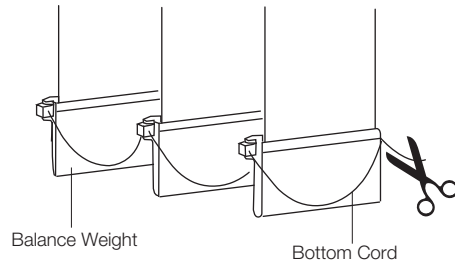

■ Checking after fitting, and removing Louvers.

- 1 Rotate the Operation Wand to confirm that the Louvers rotate properly.
- 2 The problem illustrated below is likely to have occurred if the Louvers fail to rotate properly. Referring to "Installing the Louver" in step 1 to 6 on page 7, attach the Louver correctly. Refit the Louvers so that they are correctly positioned.

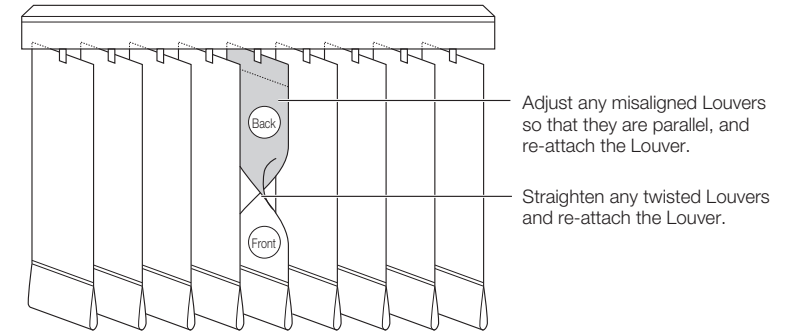

■ Removing Louvers

- 1 Move slightly the hanger section to diagonal.
- 2 Pull straight down and detach the Louver.

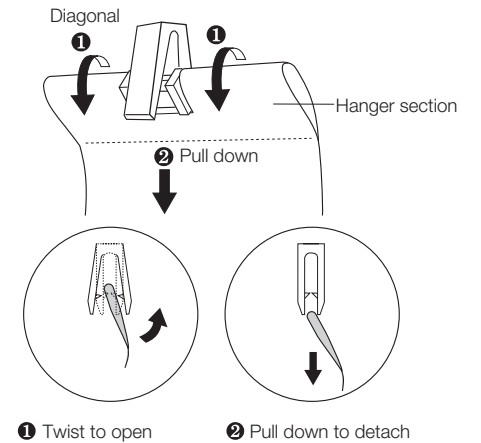

■ Uninstalling the Head Rail

<For Ceiling Attachment>

- 1 Grasp the Head Rail and hold the release button on the Bracket while pulling forward.

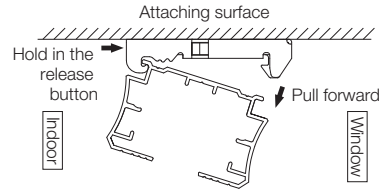

- 2 Remove the Head Rail from the temporary stopper hook.

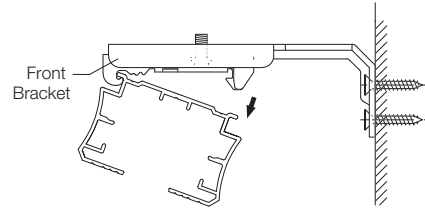

<For Front Attachment>

- Remove the Head Rail by following the above step 1 and 2.

⚠ Caution

- ⚠ When removing the Head Rail from the brackets, be sure to support it with your hand.

■ About Safety Tassel

- This Safety Tassel is a part for preventing unexpected accidents such as the Drive Cord becoming wrapped around the neck or body of a child.
- Attach the Safety Tassel to the Drive Cord using the included ring and tie the Drive Cord in a place where children cannot reach.

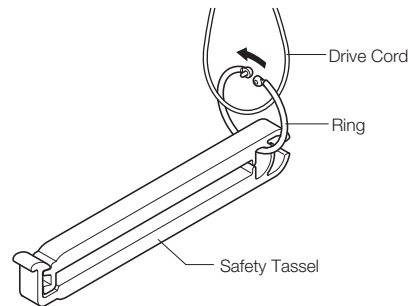

Operation Methods

■ Adjusting the Louver angle (Tilting)

- Turn the Operation Wand to adjust (Louver angle).

* When the Louver is closed, the tilt operation will become difficult. Do not turn the Operation Wand forcibly. It will cause damage.

* In case of disparities of the angle for each Louver appear when the Louver is turning, adjust the suitable angle of the Louver by turning the Operation Wand to reverse.

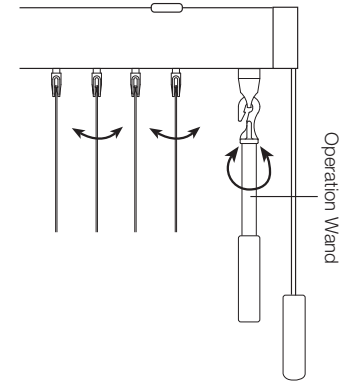

■ Opening and Closing the Louver (Drive Cord Operation)

- 1 Turn the Operation Wand and adjust the Louver to be perpendicular to the Head Rail.
- 2 Pull down the Drive Cord until the Louver is in the position and release your hand.

* Drive Cord operation is not available when the operation is wand-type.

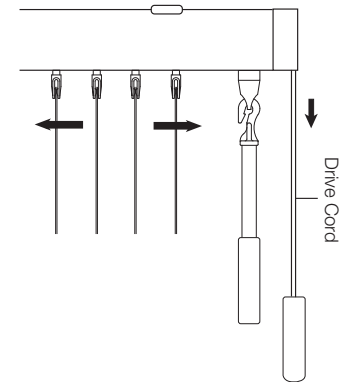

⚠ Caution

- ⚠ To prevent failure, make sure the Louvers are perpendicular to the Head Rail when opening/closing.
- ⚠ Pull the Drive Cord gently. If pulled strongly, the Louver will move rapidly and may become misaligned, which will cause to align it untidily. Also, when the Operation Wand is slid, it may swing to the side, causing damage to the window or walls.
- ⚠ When closing a Louver that is moved to the side, pull the Drive Cord slowly. If pulled quickly, the Louver slats will swing with great force, and a gap may appear between the closing side and the Operation Wand being pulled on the opposite side. If this occurs, close the gap using the Operation Wand that was moved.
- ⚠ If the Drive Cord is repeatedly operated while in a twisted position, damage to the product will occur. Remove any twists before operating the Drive Cord.

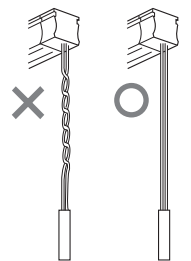

■ Opening and Closing the Louver (Wand Operation)

* If the product installation height is 3010mm or higher, Louver operation with Operation Wand is not available.

- ❶ Turn the Operation Wand and adjust the Louver to be perpendicular to the Head Rail.
- ❷ Slide the Operation Wand until Louver is in the position and release your hand.
- ❸ When closing the Louver completely, push the base of the Operation Wand into the end to avoid pull back.

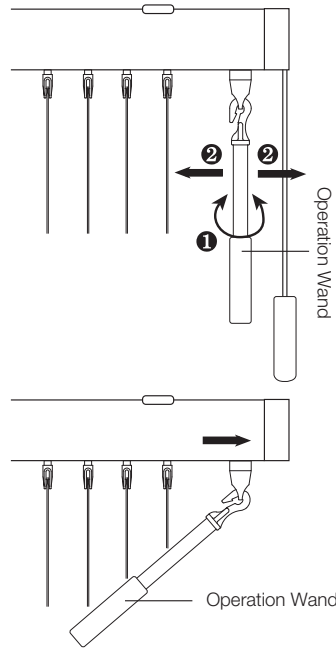

Caution

- ❶ To prevent damage, make sure the Louvers are perpendicular to the rail when opening/closing.
- ❷ Pull the Operation Wand gently. If pulled strongly, the Louver will move rapidly and may become misaligned, which will cause to align it untidily.
- ❸ When closing a Louver that is moved to the side, pull the Operation Wand slowly. If pulled quickly, the Louver slats will swing with great force, and a gap may appear between the closing side and the Operation Wand being pulled on the opposite side. If this occurs, close the gap using the Operation Wand that was moved.

Maintenance Sticker

- Your purchased product has an affixed maintenance sticker showing information related to the product. Please refer to this maintenance sticker when inquiring about the product or for repairs.

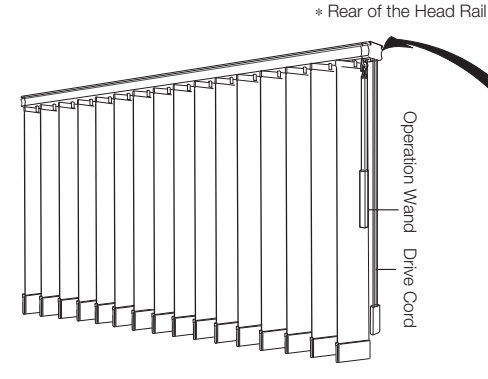

Indicates the shipping date.

❶出荷日	**年**月**日	❷受注No	*****
❸品名	デュアル100 カタビラキミキヨセ T*-*****		
	2000×2000 ミギ バトン800		
❹生産部署	***		

Indicates the product specifications.

デュアル100	カタビラキミキヨセ	T*-*****
Product name	Closing configuration	Slat code
2000 × 2000	ミギ	バトン800
Product width	Product height	Operation position
		Installation height

Cleaning

- Remove dust by wiping with a hand mop or dry cloth.
- If the Louvers become dirty, wet a cloth and tightly wring, then lightly wipe the Louvers. (Once the Louvers become wet, even by water, there may be an instance of a slight color change. Please handle them with care.)