

■ Disassembly Method of the Product

- (1) While supporting the Rail from below, loosen the Bracket screws, rotate the Fastener and remove the Rail Set from the Bracket.

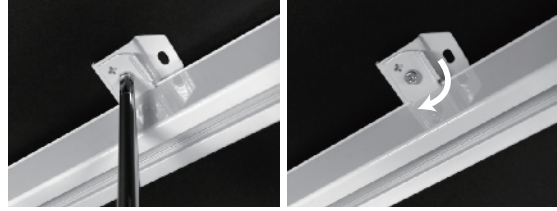

Caution

- ❗ For the Rail Set with OT Splice, this task should be performed by no fewer than two people.
- ❗ For the Rail Set with OT Splice, make sure the Joint part is adequately supported during the removing process.

- (2) Remove the mounting screws from the Bracket and then remove the Bracket itself.

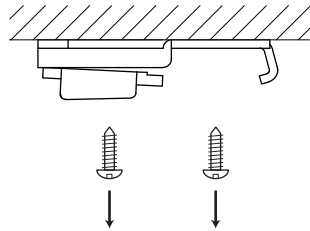

Cleaning

- Be aware that direct contact with water, wiping the product with paint thinner or other solvent, or cleaning it with chemicals could cause malfunction, discoloration or distortion.
- If the product becomes dirty, clean it by wiping with a clean, soft dry cloth.

TOSO

Motorized Curtain Tracks

Ti-8040 Rail Set

No.N-140005

First edition

Instruction Manual

Thank you for purchasing TOSO products. To ensure safe use of this product, please read the following thoroughly and keep this manual stored.

Guide for Distributors and Installation Contractors

This manual contains information for a user to safely operate this product. Please provide this manual to a customer.

INDEX

■ Caution	2
■ Product View and Part Names	4
■ Installation and Disassembly Method	6
■ Cleaning	12

CAUTION

- This manual contains cautions and instructions for safe use of the product. Please read it carefully before use and ensure appropriate use.
- This document illustrates the dangers of using this product without taking necessary precautions. Please refer to below symbols for different types of safety points.

Warning

- Illustrates when misused, there are dangers of serious injuries or possible fatal accidents.

Caution

- Illustrates when misused, there are dangers of casualties or possible physical damage of the product.



● This document illustrates safety points to be kept using below symbols.

-  Illustrates specific conducts which are prohibited.



-  Illustrates specific guidelines which are enforced.

■ Precautions upon installing the product

Warning

-  Check the foundation base and strength of the material before installing this product. If not installed properly to the foundation base, there are dangers of it falling.
-  Install a product as instructed with necessary quantity of brackets. If not the product may fall.







Caution

-  This product is intended for indoor use. Please do not use it for exterior purpose.
-  Locations subject to high temperatures and high humidity, or areas where water may leak, should be avoided.
-  Make sure to install a product horizontally.







■ Safety in Use

Warning

-  Do not hang anything on this product or do not hang down. This may cause accident.
-  Power source for this product is AC100V ~ 240V. Do not use any other power supply.
-  This product supports our designated switch only. Do not use any other switch.
-  Avoid any actions that may damage the power cord or plug. Using damaged components may result in electric shock, short circuits, or fire.
-  Clean power plugs at regular intervals. Plugs exposed to moisture or to excessive dust may lead to insulation failures or cause fires.
-  Avoid handling power plugs with wet hands. Doing so may result in electric shock.



Caution

-  When there is strong wind, please either close the window or have the curtain completely open.
-  Please do not dismantle the mechanical assembly nor lubricate the moving parts of this product. This will ensure physical damage or malfunction of the product.
-  To avoid breakage and malfunction, do not disassemble this product.
-  Please do not use it by open flames.
-  Around the area where the screen is to open and close, please remember to clear all objects which may break when placed around the screen.



Product View and Parts Names

Product View and Parts Names

● Rail Set (Without OT Splice)

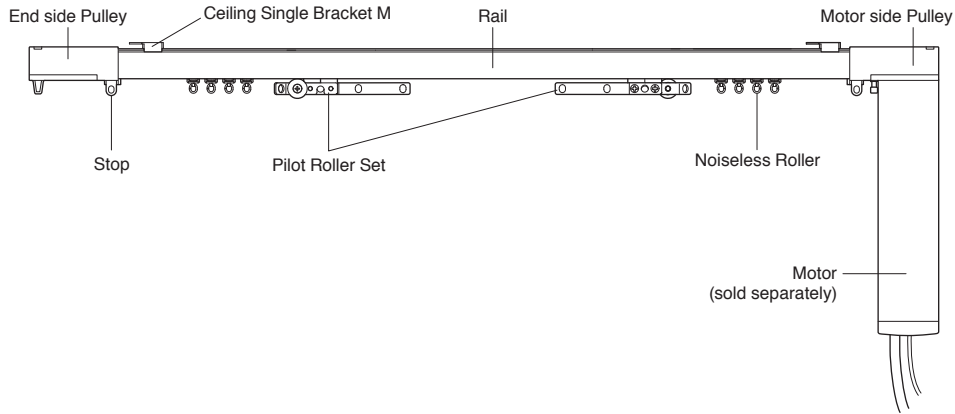

● Rail Set (With OT Splice)

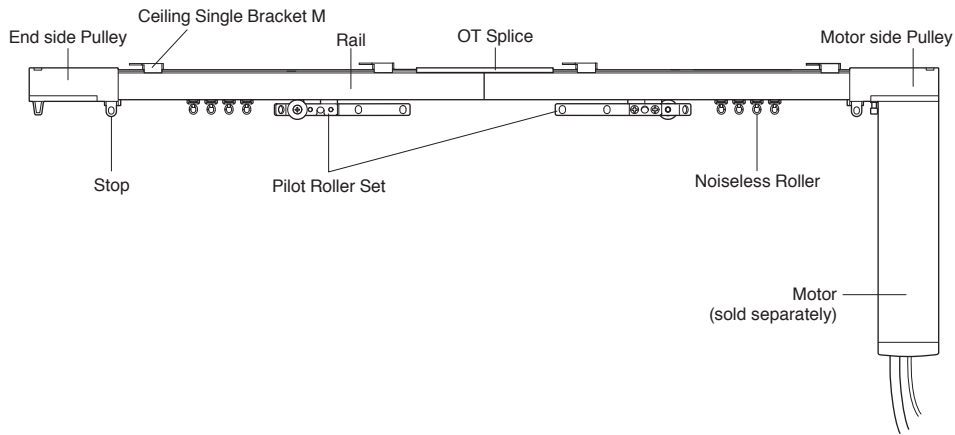

Attached Parts

● Ceiling Single Bracket M

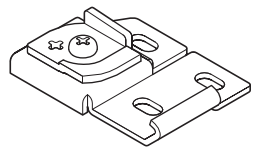

● OT Splice

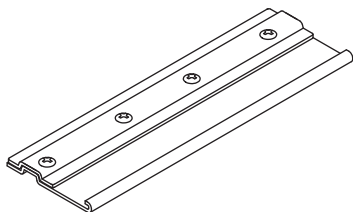

● Splice Pin

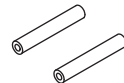

● Joint Plate (1 pc)*

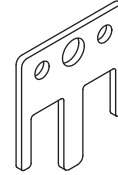

● Master Roller Arm (1 pc)*

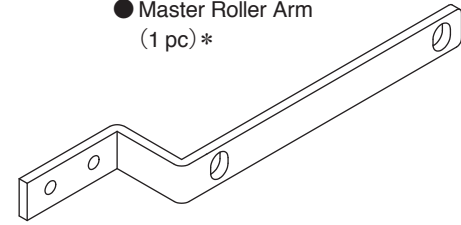

● Pilot Roller Plate with Wheel (1 pc)*

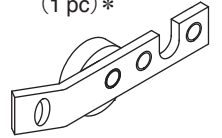

● Pilot Roller fixation Screw (2 pc)*



● Noiseless Roller (10 pcs / m)*



*For the Rail Set without a Joint, all parts are fitted to the Rail Set.

The Number Containing of Attached Parts

Specification of Rail Set	Widm Parts Name	1000	2010	3010	3510	4010	5010	6010	7010	8010	9010
		2000	3000	3500	4000	5000	6000	7000	8000	9000	10000
Straight	Bracket	4	5	6	6	8	10	12	15	15	18
	OT Splice	0	0	1	1	1	1	2	2	2	3
	Splice Pin	0	0	2	2	2	2	4	4	4	6
Single Curve	Bracket	5	6	7	7	9	11	13	15	16	18
	OT Splice	0	0	0	0	1	1	1	2	2	2
	Splice Pin	0	0	0	0	2	2	2	4	4	4
Two Curves	Bracket	6	7	8	8	10	12	14	17	18	19
	OT Splice	0	0	0	0	1	1	1	2	2	2
	Splice Pin	0	0	0	0	2	2	2	4	4	4
Overall Curve	Bracket	4	5	6	8	10	10	12	—	—	—
	OT Splice	0	0	0	1	1	1	1	—	—	—
	Splice Pin	0	0	0	2	2	2	2	—	—	—



Caution

❗ Fixing screws are not supplied for the Bracket. Select the appropriate screws suitable for the material of the base.

Installation and Disassembly Method

Installation Dimensions & Diagram

● Ceiling Single Attachment

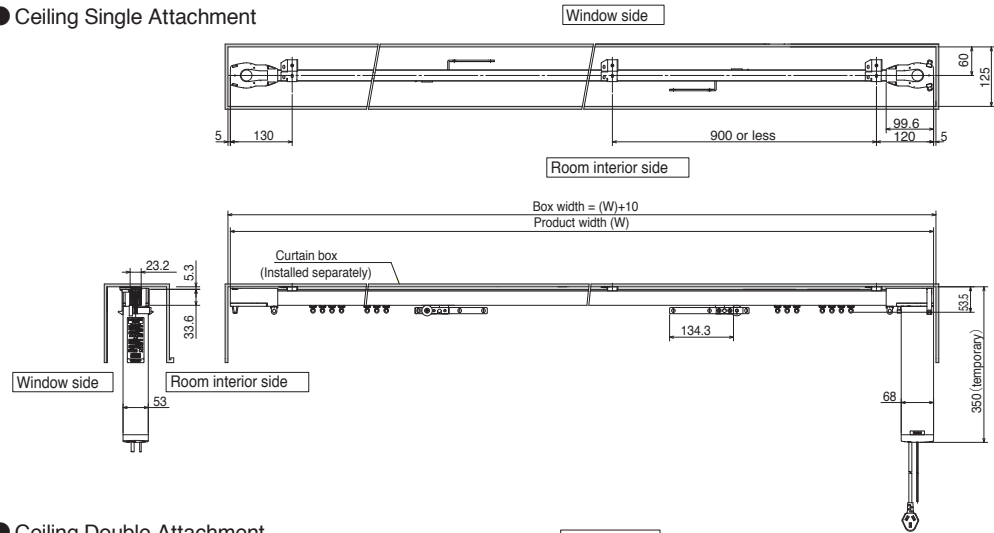

● Ceiling Double Attachment

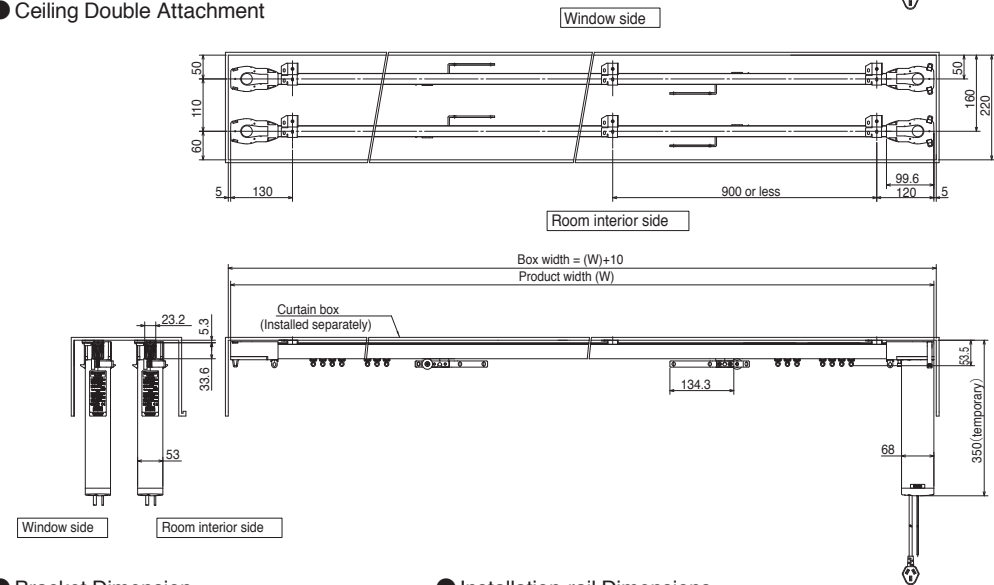

● Bracket Dimension

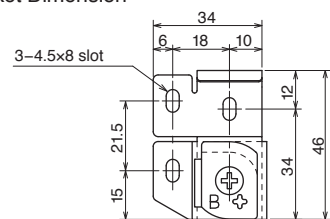

● Installation-rail Dimensions

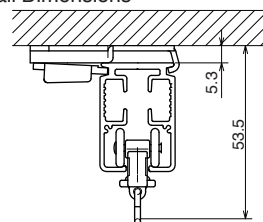

How to Assemble the Rail Set(With OT Splice)

● For the Rail Set with OT Splice, joint the Rail by the procedure described below before fitting.

(1) Loosen the OT Splice Screw and insert the Rail by sliding along the OT Splice groove.

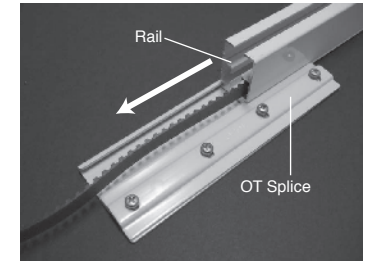

(2) Inset the Splice Pin into the opening of a Rail. (If insertion is difficult, tap with a wooden hammer or similar tool.)

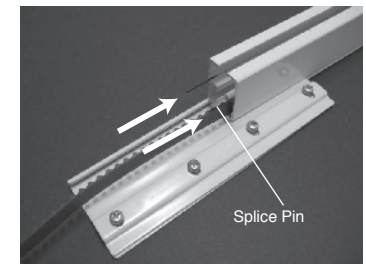

(3) Inset the other Rail into the OT Splice. (If insertion is difficult, cover the Pulley with a cloth and tap with a wooden hammer or similar tool.)

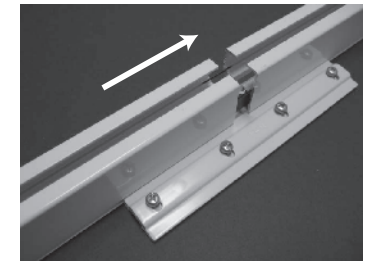

(4) Position the Rail so that the joint section is at the center of the OT Splice, then tighten the screws of the OT Splice.

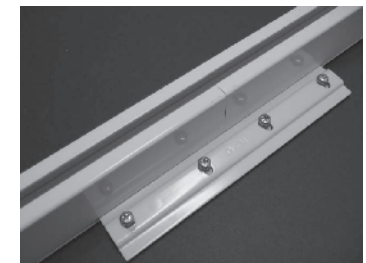

⚠ Caution

❗ Check to confirm that the OT Splice is securely attached to the Rail.

(5) Place the Pilot Rollers end to end.

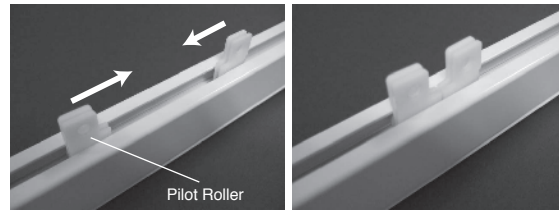

(6) Joint the Pilot Rollers by the Joint Plate.

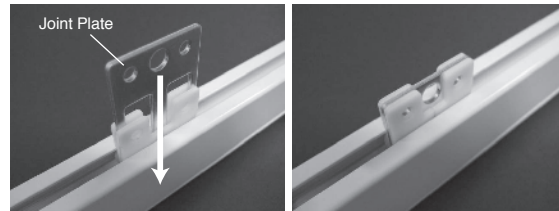

(7) Fix Master Roller Arm and Pilot Roller Plate with Wheel by the Pilot Roller attachment screw.

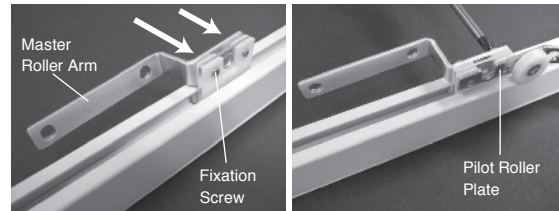

(8) Loosen the Stop screw by a screwdriver, and remove the Stop.



(9) Insert Noiseless Rollers and secure the Stop into place. (Two-way draw, insert the same number of Noiseless Rollers from the Pulley at both ends.)



Caution

When securing the Stop into position, fit in such a way that the convex portion of the Stop fits into the concave portion of the Pulley. Align carefully; an improper fit may cause the Stop to fall off.

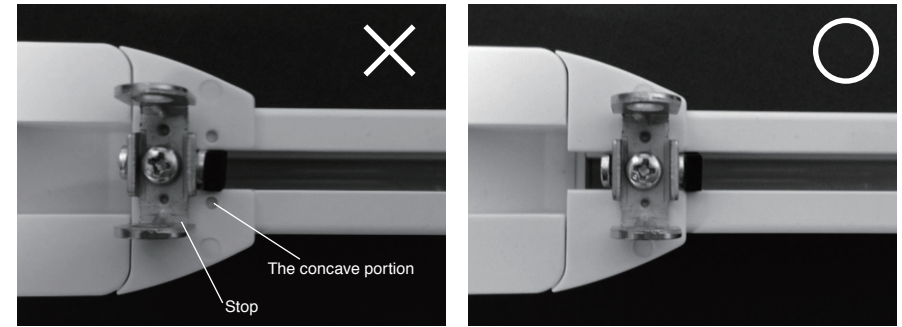

Location of Brackets

(1) Refer to chart below, determine the locations of the Brackets.

(2) For the Rail Set with OT Splice, fit Brackets to both sides of the OT Splice.

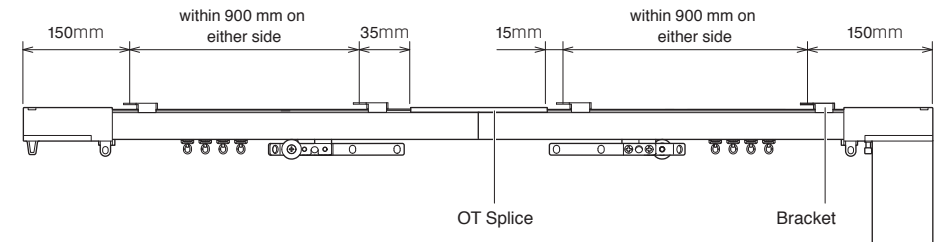

Installing Method of the Product

※ After affixing the Bracket to the mounting surface, mount the Rail Set.

(1) Before affixing the Bracket, loosen the Bracket screw and rotate the Fastener.

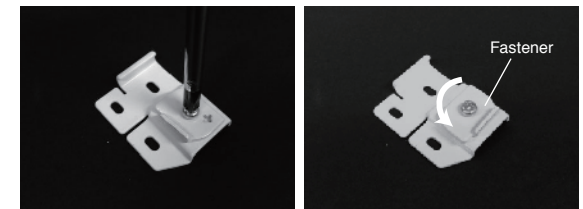

- (2) Mount only the Bracket at the designated Bracket mounting position on the mounting surface and affix it using screws.

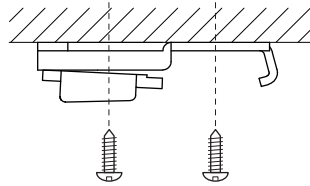

Caution
 When affixing Brackets, use 2 screws for each Bracket. Using an insufficient number of screws per Bracket may cause the product to fall.

- (3) Insert cardboard pads in the rail groove at a 1-meter interval. (Use cardboard from the product packaging.)

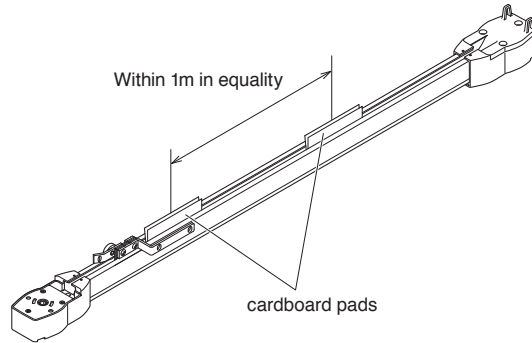

Caution
 Make sure to insert the cardboard pads before lifting the Rail up. Failure to do so may cause the belt to fall out.

- (4) Line the affixed bracket up with the rail and position it so that the Bracket Fastener straddles the Rail groove.

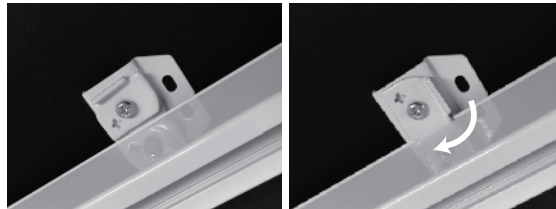

- (5) Tighten the screws and secure it firmly in place.



Caution

- For the Rail Set with OT Splice, this task should be performed by not fewer than two people.
- For the Rail Set with OT Splice, make sure the Joint part is adequately supported during the mounting process. The product may fall off.
- Check to make sure that the Rail is firmly attached to the Bracket.

Installation Method of the Motor

- (1) Pull the Ti-8040 motor section's Fixing Lever downward while sliding it to the left and insert the Motor set into the Motor side Pulley.

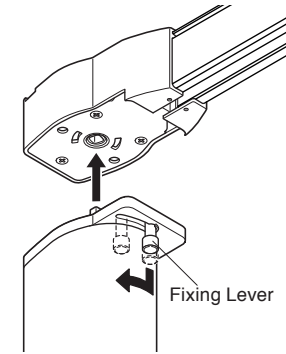

- (2) Slide the Fixing Lever to the right and make sure that it has returned from a downward to an upward position.

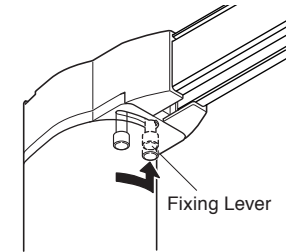

- (3) Lastly, install the 2 Curtain hooks included with the product on both sides of the Motor side Pulley to complete installation.

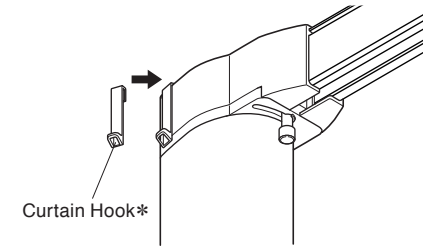

*Curtain Hooks packed in Motor Set box.

Caution
 Check to confirm that the Motor is securely attached to the Rail Set. (Pull down on the Motor to confirm that it is securely mounted.)

Disassembly Method of the Motor

- Pull the Fixing Lever downward while sliding it to the left and remove the motor.