

TOSO

Electric wave Remote-control Switch

FM Remote-Control Receiver 2.4G with IR terminal

No.N-10093003

Instruction Manual

Thank you for purchasing TOSO products. To ensure safe use of this product, please read the following thoroughly and keep this manual stored.

Guide for Distributors and Installation Contractors

This manual contains information for a user to safely operate this product.
Please provide this manual to a customer.

INDEX

■ Caution	2
■ Instructions and directions for use.....	3
■ Product View and Part Names	4
■ Installation.....	6
■ Connection method.....	7
■ Setting of address number.....	8
■ Check the operation.....	9
■ Troubleshooting	10
■ Product Specification.....	11
■ Cleaning	11
■ Disposal of Packing Materials	11

CAUTIONS

* This manual contains cautions and instructions for safe use of the product. Please read it carefully before using to ensure appropriate use.

● This document illustrates the dangers of using this product without taking necessary precautions. Please refer to the symbols below for different types of safety points.



Warning

Illustrates that if this product is misused, there are dangers of serious injuries or possible fatal accidents.



Caution

Illustrates that if this product is misused, there are dangers of casualties or possible physical damage of the establishment or home furniture.

● This document illustrates safety points to be followed using the symbols below.



Illustrates specific actions which are prohibited.



Illustrates specific guidelines which must be followed.

■ Precautions upon installing the product (Please read before installation.)



Warning

- ⊘ This product is intended for indoor use. Please do not use it for outdoor purposes.
- ⊘ Locations subject to high temperatures and high humidity, or areas where water may leak, should be avoided.
- ⊘ Do not use this product close to a TV, radio transmitting station or area with strong magnetic force. Transmitting distance may be shortened or may not operate correctly.
- ❗ When installing the product, examine the strength and quality of the backing material.
- ❗ The provided securing screws are for wood only. For other wall materials, please use the appropriate screw type.



■ Safety in Use (Please read thoroughly)



Warning

- ⊘ Do not touch the product with a wet hand as there are dangers of electrical shock.
- ⊘ Do not use this product in places where it may come into direct contact with water. Fire or electrical shock may occur.



Caution

- ⊘ This product is for TOSO motorized products only. Do not use it for any other products.
- ⊘ Do not attempt to disassemble this product. For repair, consult your original retail shop.
- ❗ Strong shocks may cause damage to this product.
- ❗ Do not place this product close to a strong magnetic force. The electronic components of this receiver may not function properly if affected by a strong magnetic force.
- ⊘ Please do not use this product around open flames.
- ⊘ Do not attempt to operate the product other than instructed.
- ⊘ Around the area where the motorized product is to open and close, please remember to clear all objects.



Instructions and directions for use

- This product is a radio device that uses the 2.4 GHz band.
- This product uses a frequency band utilized in many industrial, scientific, and medical devices such as microwave ovens in addition to the mobile identification internal radio stations used by factory production lines and special low-power radio stations.



Warning

- ⊘ Do not place or use this product near medical devices.
- ⊘ Do not bring this product into an operating room, ICU, or CCU, etc.
- ⊘ Keep this product at least 22 cm away from a person with an artificial pacemaker. Radio waves from this product can affect artificial pacemakers.



Caution

- ❗ Before using this product, be sure to check that there are no mobile identification internal radio stations for factory production lines or special low-power radio station in use nearby.
- ❗ To reduce radio wave interference, keep this product away from the following products as much as possible: microwave ovens, wireless LAN devices, digital cordless telephones or fax machines, audio-visual or office automation equipment with radio transmission.

Product View and Part Names

Product View · Part Names

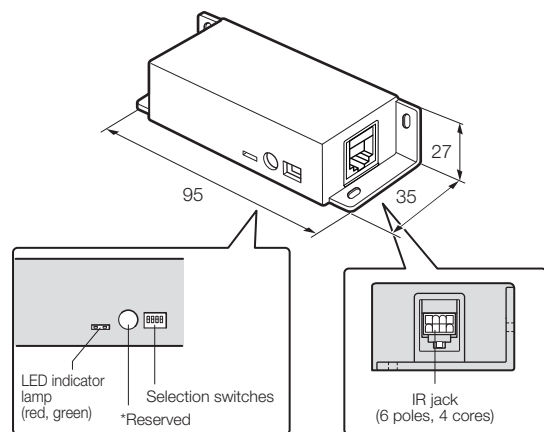

Accessories



Fixing Screw

(Round head Ø4×20.....for receiver, 2 pieces)

Optional (Sold separately)

- Modular cord (six-poles, four-cores)

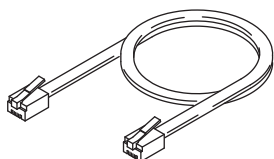

FM Remote-control transmitter 2.4G (Sold separately)

- Product View

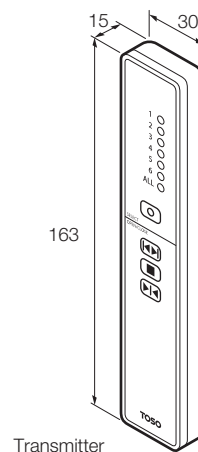

- Accessories

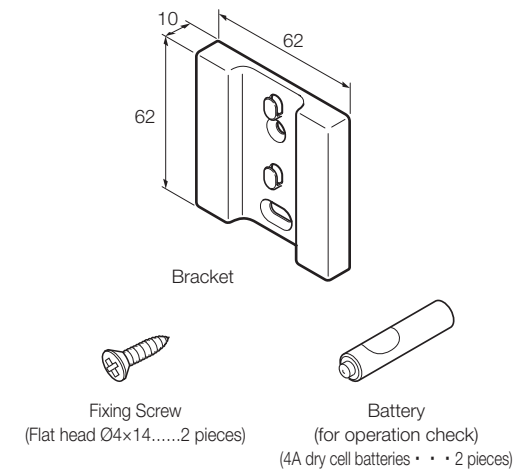

- Parts Name

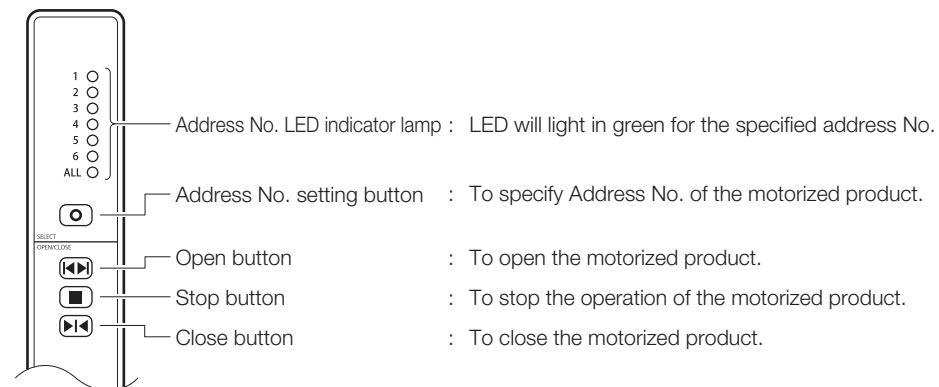

Installation

Caution

- ❗ When operating 2 or more receivers, separate them by a distance of at least 1m, otherwise it may cause radio interference.
- ❗ When using Linear Motor Curtain Rail Bestec 21, keep the receiver at least 3m away from the rail.
- ❗ Keep the receiver at least 1m away from metal and concrete.
- ❗ When mounting on a ceiling, keep at least 50 cm away from metal beams, c-channels, etc.
- ⊘ Do not cover the receiver with metal materials or concrete, etc.
- ⊘ Do not place near telephone lines, internal wiring, televisions, computers, or other transmission/electronic devices.
- ⊘ Locations subject to high temperatures and high humidity, or areas where water may leak, should be avoided.
- ❗ The provided securing screws are for wood only. For other wall materials, please use the appropriate screw type.

- 1 Decide the mounting location based on the following product dimensions.

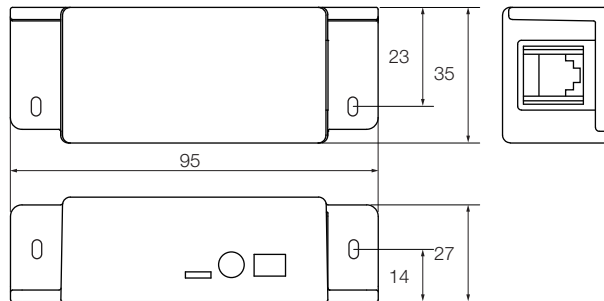

- 2 Mount with the included mounting screws (2 pieces).

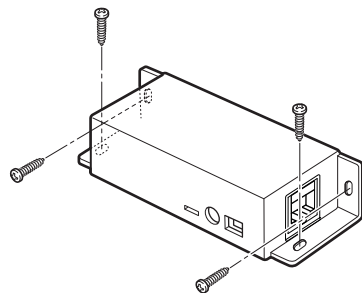

Connection method

Warning

- ⊘ When connecting, do not turn on the power of the product or the electrical device.

■ [Motorized Curtain Tracks] Progress 50

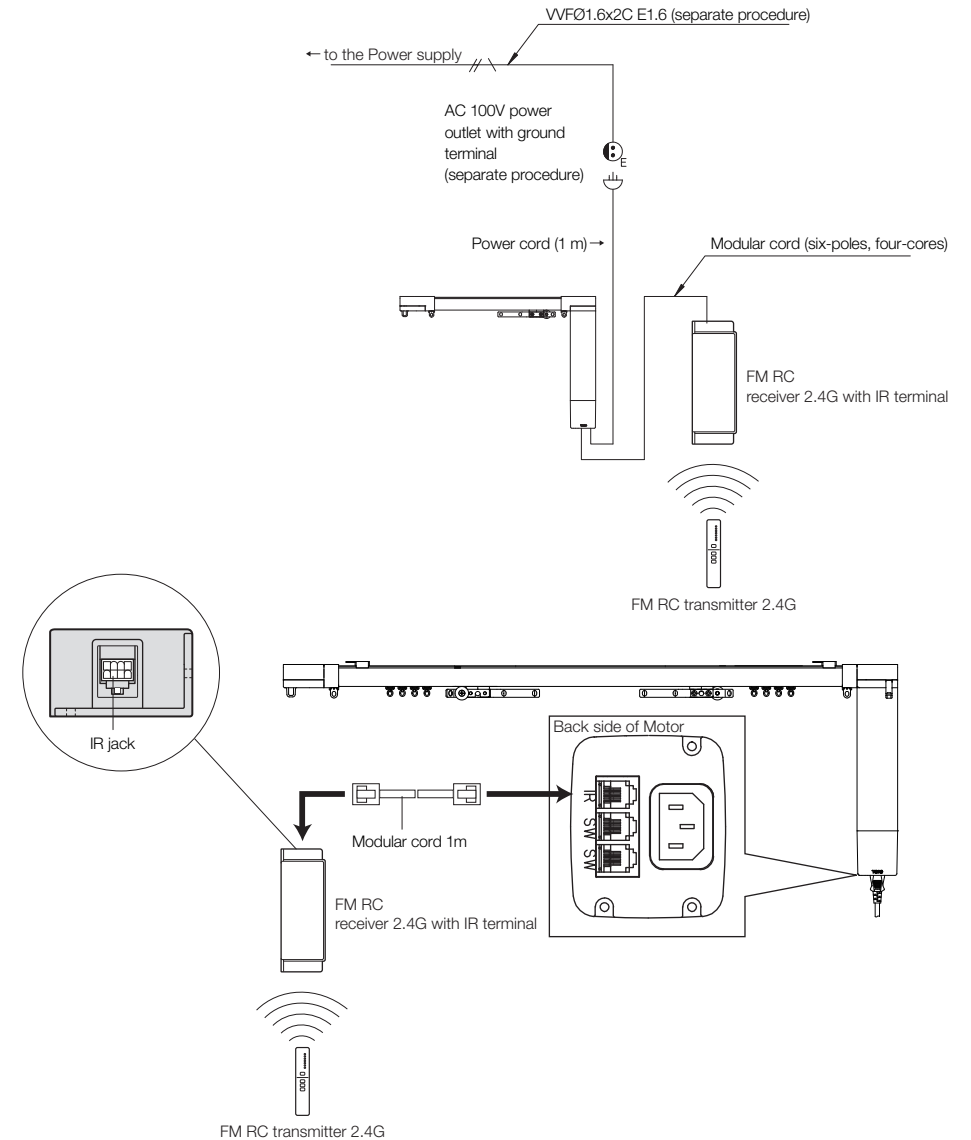

Setting of address number





Caution

- ❗ The address number of the receiver is not registered after shipping.
- ❗ Use the separately sold FM Remote Control Transmitter 2.4G to register the address number of the receiver. (The receiver will only receive transmissions used by a transmitter with address number registration.)

Registration Method

- * To use FM Remote Control Transmitter 2.4G (sold separately), see the FM Remote Control Transmitter 2.4G instructions.
- * Register the address number of receivers one at a time.

- 1 Properly connect the modular cord to the main unit and FM remote control receiver 2.4G with IR terminal.
- 2 When No.1 of the various setting switches on the receiver is set to ON, the red LED will light. When the green LED flashes, registration mode will be active.
- 3 Press the  Address No. setting button on the transmitter to make the address display LED light up for the address number you want to register.
- 4 Press and hold in the  stop button on the transmitter for at least two seconds.
- 5 When transmissions are received, the red LED and the green LED will simultaneously flash three times and then light.
- 6 When No.1 of the various setting switches on the receiver is set to OFF, the red LED will turn off and registration will be complete.

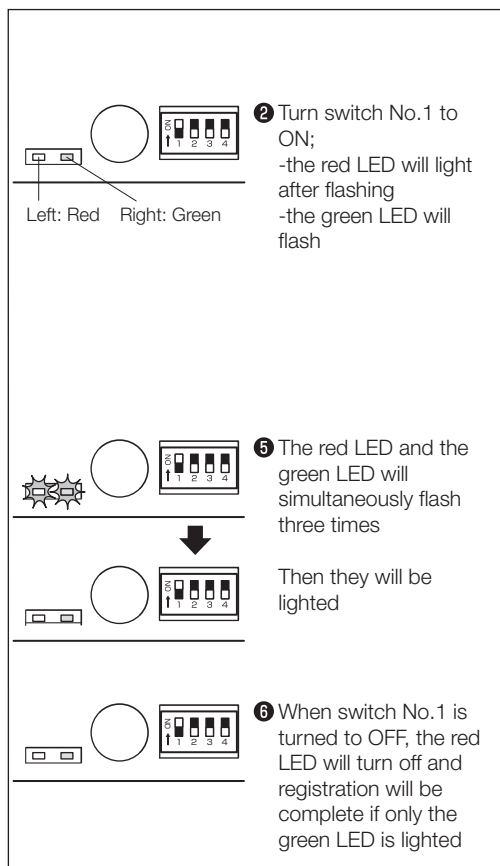

Deleting an address number

* All receiver address numbers will be deleted.

- 1 Properly connect the modular cord to the main unit and FM remote control receiver 2.4G with IR terminal.
- 2 When No.2 of the various setting switches on the receiver is set to ON, the red LED will light after flashing and the green LED flashes.
- 3 When No.2 of the various setting switches on the receiver is turned to OFF the red LED will turn off. When the green LED lights, deletion of all address numbers will be complete.

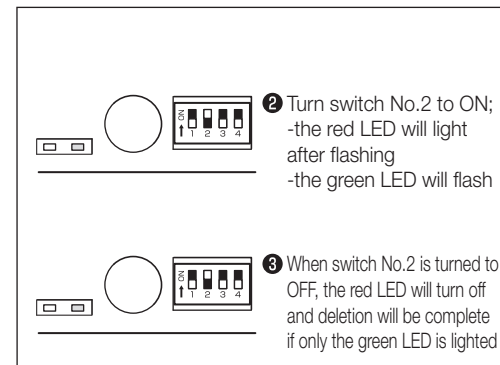

Changing a registered address number





- After deleting a registered address number using the deletion method, re-register the address number.
- * If a different address number is registered on the same receiver without deleting the previous number, the previous address number will still be registered.

<If the registered address number is no longer known>

- Transmit address numbers 1-6, if the green LED on the receiver flashes once (or if the receiver makes a clicking sound), the address number is registered. If the green LED doesn't flash or if there is no sound, the address number is not registered.

Check the operation

Receiver

- 1 Confirm that the connections are properly made.
- 2 Press the  Address No. setting button on the transmitter to display the registered address number on the address display LED.
- 3 Press the , , or  Stop button on the transmitter. If the green LED on the receiver flashes once, the address number is registered.

Motorized product main unit

- 1 Confirm that the connections are properly made, then insert the power plug into an outlet.
 - 2 Press each button on the transmitter to confirm the operation of the electrical device connected to the receiver.
- * For operation of FM Remote Control Transmitter 2.4G, see the FM Remote Control Transmitter 2.4G instructions.

Troubleshooting

Condition		Possible Causes and Solution
Not operating	Transmitter's Address LED indicator does not light	<ul style="list-style-type: none"> ● Batteries not placed. ⇒ Please fit in batteries. ● Batteries placed in reverse direction. ⇒ Please place batteries in correct direction.
	Receiver's LED green light does not blink	<ul style="list-style-type: none"> ● Power is not turned ON. ⇒ Properly connect the modular cord to the receiver and the main unit.
	Receiver's LED green light does not blink when transmitter's button is pressed.	<ul style="list-style-type: none"> ● Address No. registered in the receiver has not been set. ⇒ See p.9 in the "Setting of address number" of the FM Remote control receiver 2.4G's operation manual for setting procedure and set the Address No. in the receiver.
	Others	<ul style="list-style-type: none"> ● Receiver is not properly connected to the motorized product. ⇒ See p.7 in the "Connection Method" of the FM Remote control receiver 2.4G's operation manual for setting procedure and properly connect the receiver to the product. ● Receiver is set near a metal or concrete object that reflect electromagnetic waves. ⇒ Place the receiver 1m or more away from the object that reflect electromagnetic waves. ● 2 or more receivers are set close to one another. ⇒ Set apart the receivers at least 1m away from each other. ● Receiver is set close to electrical and electronic equipment. ⇒ Set apart the receivers at least 1m away from electrical and electronic equipment.
Unstable operation	Transmitter's Address LED indicator displays ON and OFF intermittently.	<ul style="list-style-type: none"> ● Batteries are old. ⇒ Replace old batteries with new batteries.
	Others	<ul style="list-style-type: none"> ● Receiver is set near a metal or concrete object that reflect electromagnetic waves. ⇒ Place the receiver 1m or more away from the object that reflect electromagnetic waves. ● 2 or more receivers are set close to one another. ⇒ Set apart the receivers at least 1m away from each other. ● Receiver is set close to electrical and electronic equipment. ⇒ Set apart the receivers at least 1m away from electrical and electronic equipment.

Product Specification

Source Voltage	DC5V
Power Frequency	50/60 Hz
Source Current	40mA or lower
Reception Frequency	2.4 GHz
Modulation	FSK
Output	Relay output
Ambient Temperature	0~50 °C (Non-condensing)
Product Size	W 95 mm x H 35 mm x D 27 mm
Product Weight	Approx. 40 g
Antenna	Internal

Cleaning

- Whenever necessary, wipe the product with dry, clean, and soft cloth.
- Refrain from directly applying water, thinner or other chemicals to the product. Those materials may cause damages, discoloring, and distortion to the product.

Disposal of Packing Materials

- Do not leave packing material at the installation site.
- Separate combustible cardboard from noncombustible waste.
- Observe the local waster separation regulations when disposing of the materials.