

Motorized Curtain Tracks

Progress 25 · 50 Motor Set

No.N-190012

First edition

Instruction Manual

Thank you for purchasing TOSO products. To ensure safe use of this product, please read the following thoroughly and keep this manual stored.

Guide for Distributors and Installation Contractors

This manual contains information for a user to safely operate this product. Please provide this manual to a customer.

INDEX

■ Caution	2
■ Product View and Part Names	4
■ Wiring Method	6
■ Connection Method	9
■ Connecting the various switches	11
■ Setting Method of the various switches	11
■ Limit Setting	14
■ Check the Operation	16
■ Product Specification	18
■ Cleaning	18
■ Disposal of Packing Materials	18
■ Troubleshooting	19

CAUTIONS

- * This manual contains cautions and instructions for safe use of the product. Please read it carefully before using to ensure appropriate use.
- * Operating noise of this product is less than 70dB.

- **This document illustrates the dangers of using this product without taking necessary precautions. Please refer to the symbols below for different types of safety points.**

 **Warning** Illustrates that if this product is misused, there are dangers of serious injuries or possible fatal accidents.

 **Caution** Illustrates that if this product is misused, there are dangers of casualties or possible physical damage of the product.

- **This document illustrates safety points to be followed using the symbols below.**

 Illustrates specific actions which are prohibited.



 Illustrates specific guidelines which must be followed.

■ Precautions upon installing the product (Please read before installation.)

Warning

- ! Check the foundation base and strength of the material before installing this product. If not installed properly to the foundation base, there are dangers of it falling.
- ! Install this product as instructed with the necessary quantity of brackets. Otherwise the product may fall.
- ! This is a class A product. In a domestic environment, this product may cause radio interference in which case the user may be required to take adequate measures.
- ! The drive shall be disconnected from its power source during cleaning, maintenance and when replacing parts.











Caution

-  This product is intended for indoor use. Please do not use it for outdoor purposes.
-  Locations subject to high temperatures and high humidity, or areas where water may leak, should be avoided.
- ! Make sure to install this product horizontally.







■ Safety in Use (Please read thoroughly)

Warning

-  This is a class A product. In a domestic environment this product may cause radio interference in which case the user may be required to take adequate measures.
-  Please do not hang from or pull on this product. This may damage the product or cause it to fall down.
-  This product requires an AC 220–230V power source. Do not use any other power source.
-  Unplug the power cord from the outlet if the product will not be used for a long time.
-  Avoid any actions that may damage the power cord or plug. Using damaged components may result in electric shock, short circuits, or fire.
-  Clean power plugs at regular intervals. Plugs exposed to moisture or to excessive dust may lead to insulation failures or cause fires.
-  Do not touch the product with a wet hand as there are danger of electrical shock.
-  This appliance is not intended for use by persons (including children) with reduced physical, sensory or mental capabilities, or lack of experience and knowledge unless they have been given supervision or instruction concerning use of the appliance by a person responsible for their safety.
-  This appliance can be used by children aged from 8 years and above and persons with reduced physical, sensory or mental capabilities or lack of experience and knowledge if they have been given supervision or instruction concerning use of the appliance in a safe way and understand the hazards involved.
-  Children shall not play with the appliance.
-  Cleaning and user maintenance shall not be made by children without supervision.



Caution

-  When there is strong wind, please either close the window or have the curtain completely open.
-  Please do not dismantle the mechanical assembly nor lubricate the moving parts of this product. This will ensure physical damage or malfunction of the product.
-  To avoid breakage and malfunction, do not disassemble this product.
-  Please do not use it by open flames.
-  Around the area where the screen is to open and close, please remember to clear all objects which may break when placed around the screen.



Product View and Part Names

Product View · Part Names

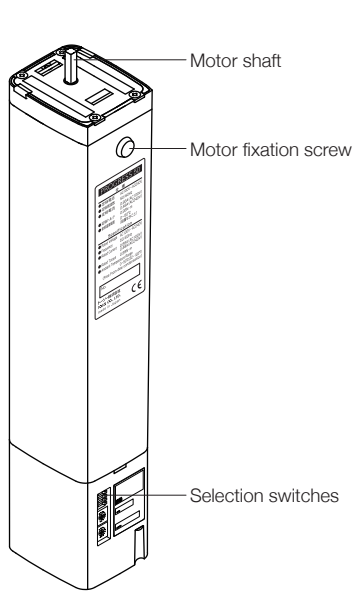

Progress50 Motor Set Dimension (mm)

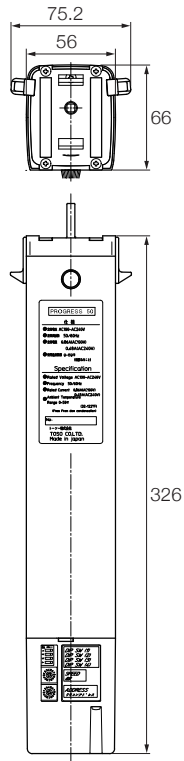

Accessories

● Curtain Hook x 2pcs

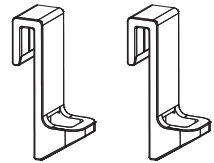

● Power cord 1 m x 1

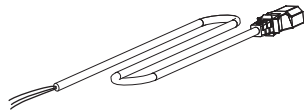

● Infra-red Receiver 01

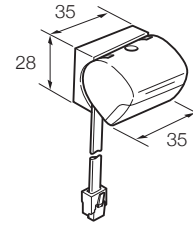

● Infrared remote control (9ch)

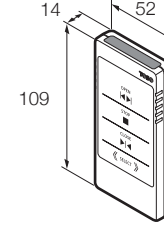

● 3 button switch
(Wide switch plate +
Inlay wide switch 3 button A)

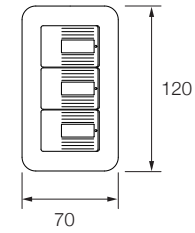

● Modular Plate for
Single (6 poles)

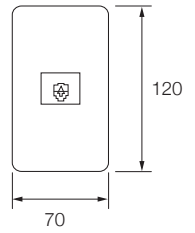

● Modular cord
(1 m) (6 poles)

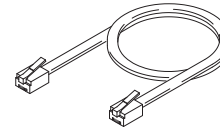

● FM Remote-control
transmitter 2.4G (6ch)

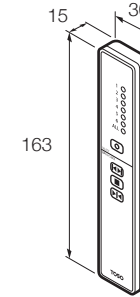

● FM Remote-control
transmitter 2.4G (7ch)

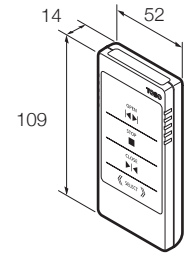

● FM Multi remote-control transmitter 2.4G

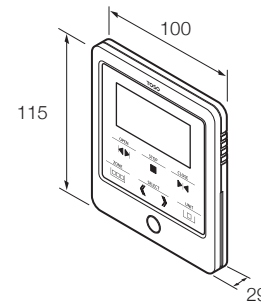

● FM Remote-control receiver 2.4G with IR terminal

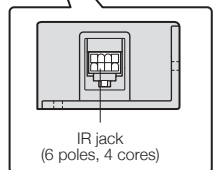
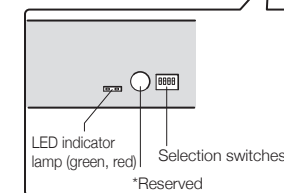
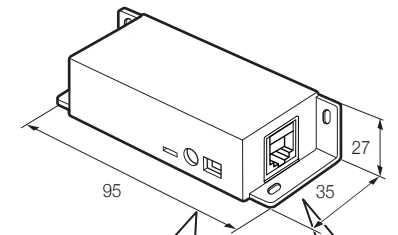

Wiring Method



Caution

- ❗ Be sure to consult with a TOSO representative and an electrician before installing power cables/operation cables. In addition, hire an electrician to install and connect cables.
- ❗ Entrust the wiring and connection work to the electrical contractor.
- ⊘ While the connection work is underway, do not activate the power. Failure to observe this precaution may lead to electric shock.

Individual operation

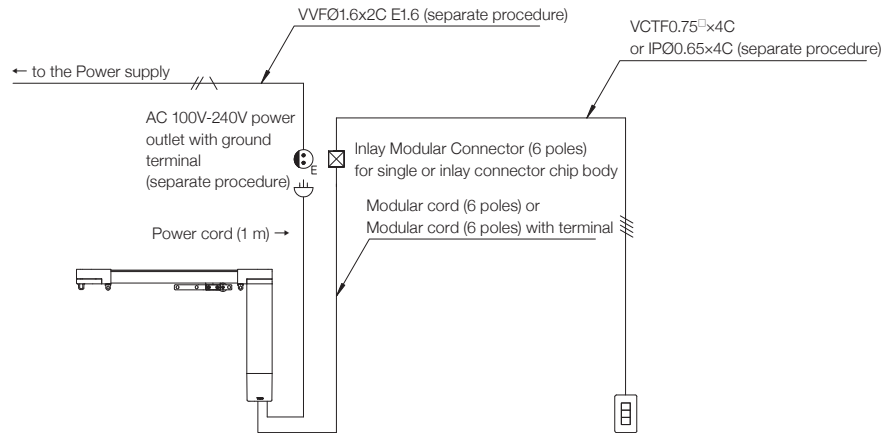

Two-point operation

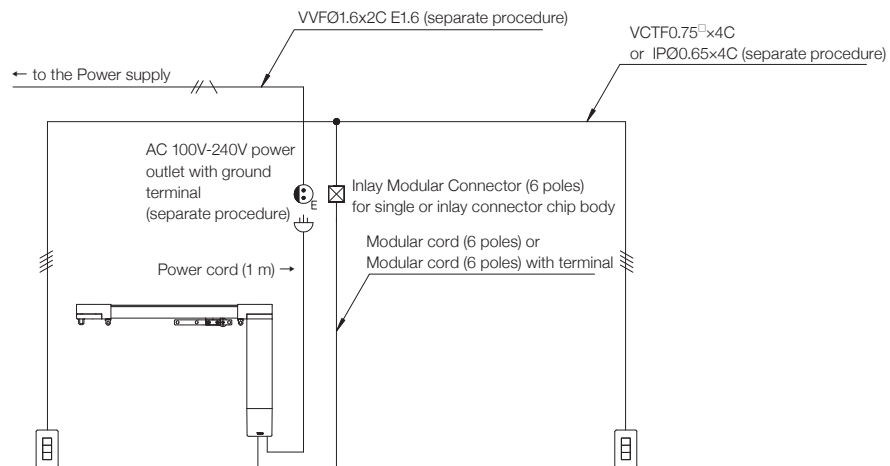

Simultaneous operation

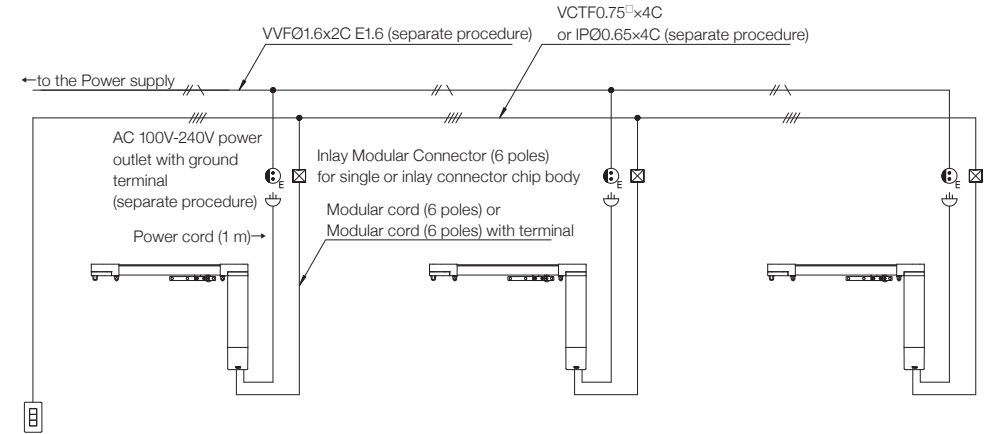

Simultaneous selective operation

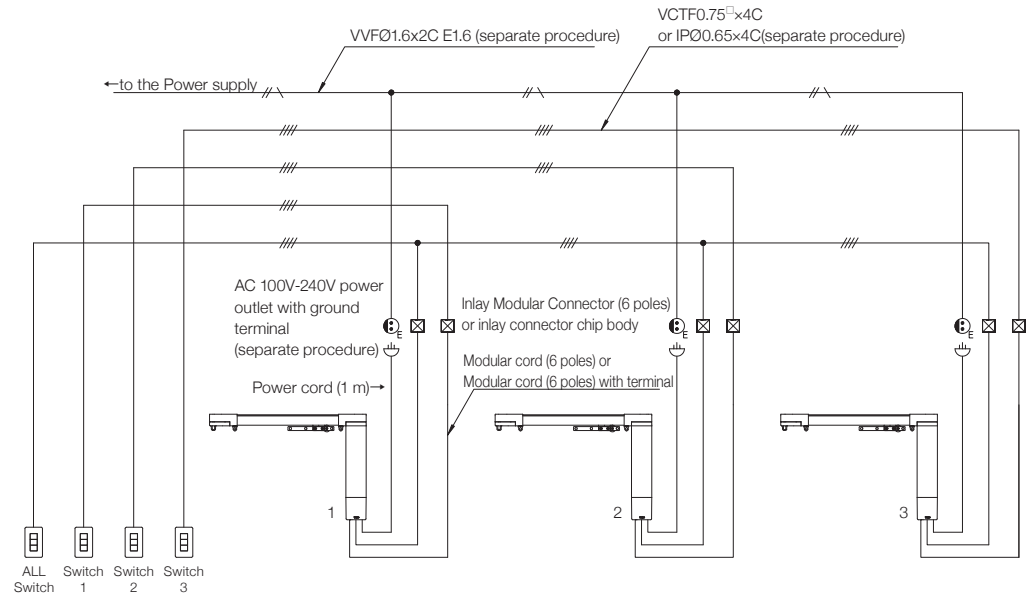

Infrared remote control operation

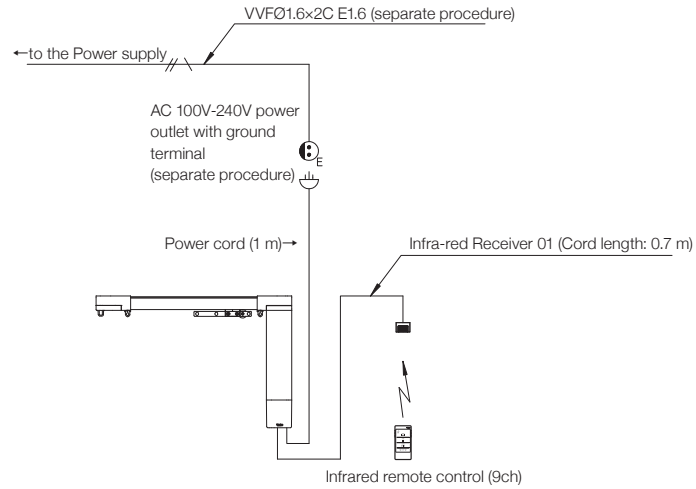

FM remote control operation

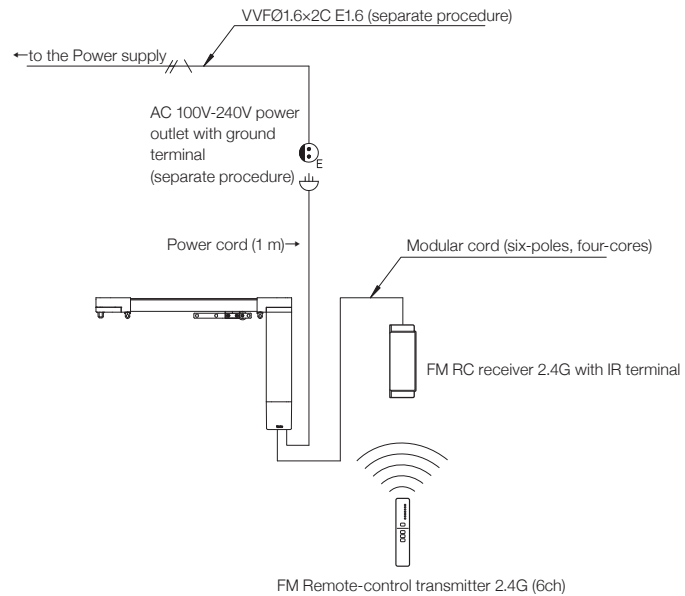

Connection Method



Caution

- ⚠ Be sure to consult with a TOSO representative and an electrician before installing power cables/operation cables. In addition, hire an electrician to install and connect cables.
- ⚠ Entrust the wiring and connection work to the electrical contractor.
- ⊘ While the connection work is underway, do not activate the power. Failure to observe this precaution may lead to electric shock.

Individual operation

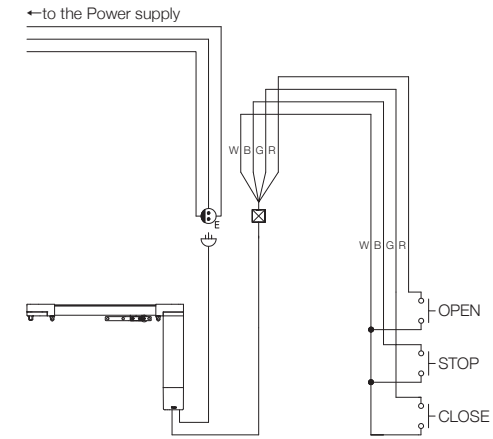

W : White
B : Black
G : Green
R : Red

Two-point operation

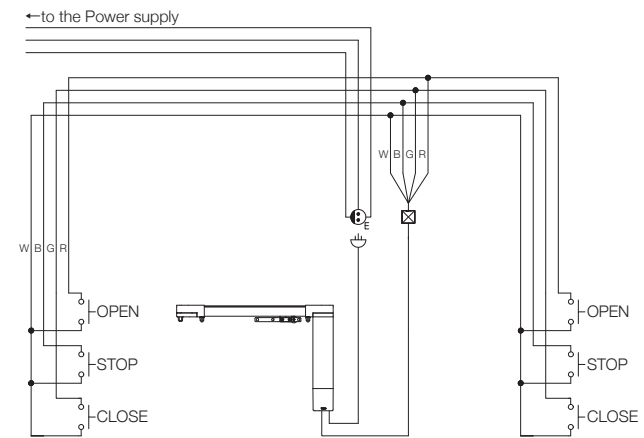

W : White
B : Black
G : Green
R : Red

■ Simultaneous operation

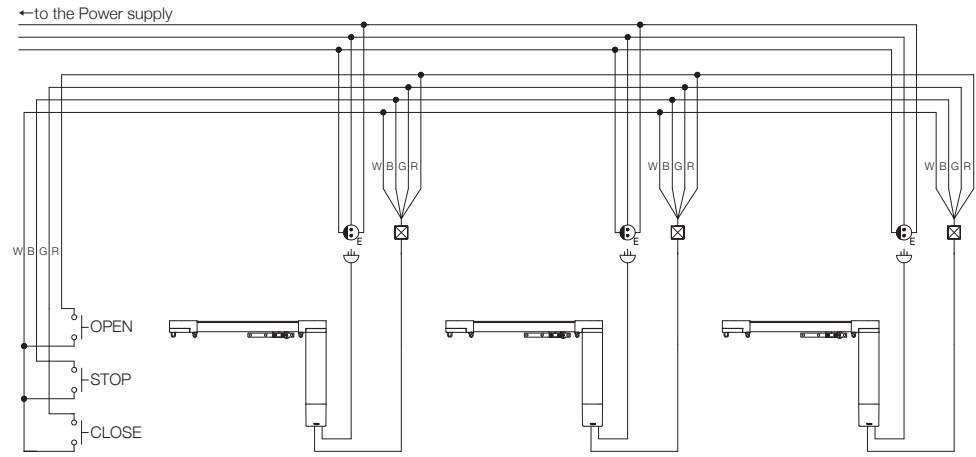

W : White
B : Black
G : Green
R : Red

■ Simultaneous selective operation

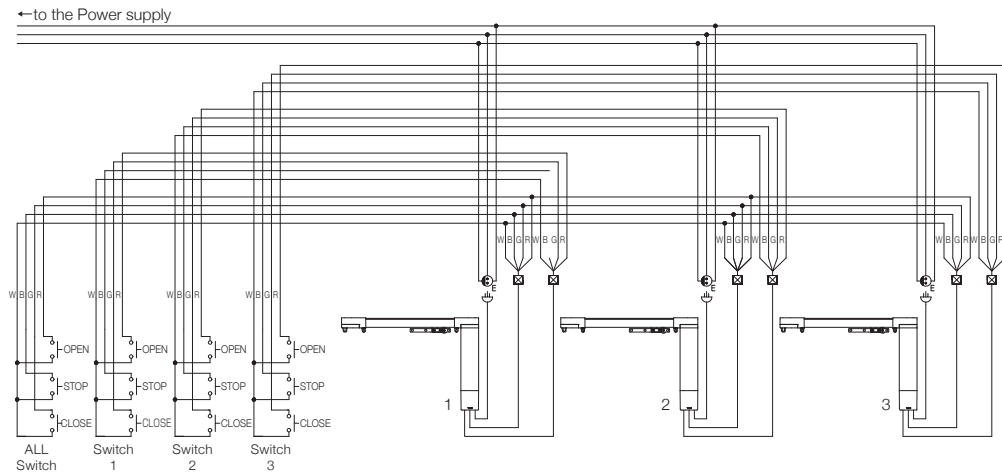

W : White
B : Black
G : Green
R : Red

Connecting the various switches

- Follow the procedures illustrated in the figures below to connect the various switches to the main unit.

<3 Button Switch and Infrared Remote Control>

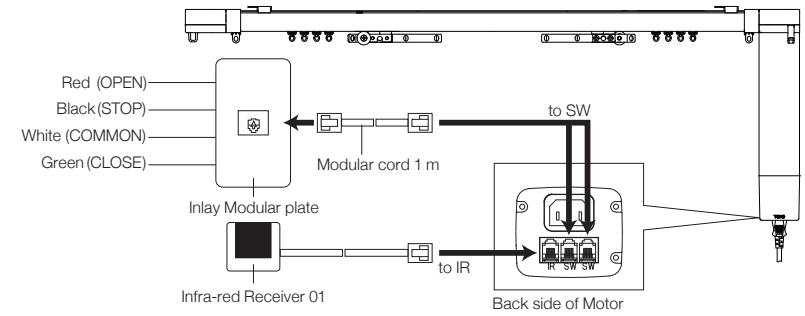

<FM Terminal>

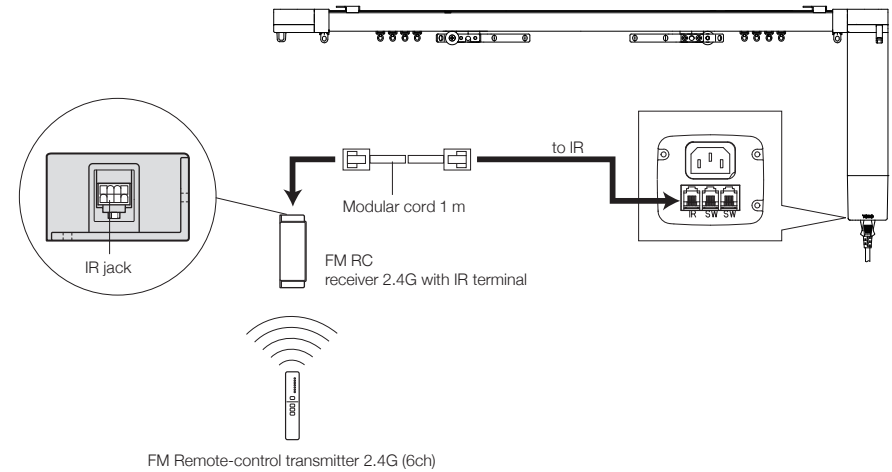

Setting Method of the various switches

- Basic operating parameters or controls, including speed settings, can be set or controlled using the switches on the Motor unit.

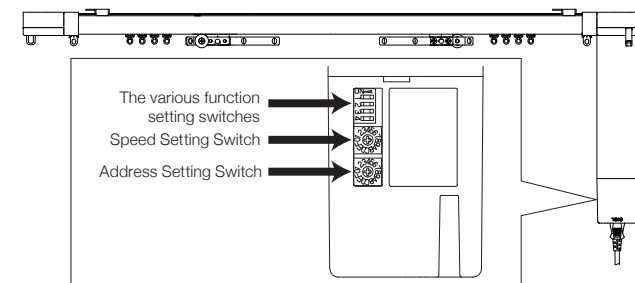

■ Function Setting of DIP Switch

- The control switches are used to set the functions for various operating switches.
- When shipped, all switches are set by default to their OFF positions.

	Functions to be set	ON	OFF
Switch 1	The setting operations of Two-button and three-button	Two-button	Three-button
Switch 2	The setting operation of self hold circuit on Two-button	Function to be set	Function to be not set
Switch 3	Enables/disables Touch-motion functions	Enable	Disable
Switch 4	Switches motor rotation direction	Reverse	Normal

<The Touch-Motion Function>

- Touch-Motion Function enables opening/closing of curtains without using any switch operations.
 - By pulling the curtain (Pilot Runner will move 5cm), the curtain will move (motor will operate in the corresponding direction) and stop at Limit Position.
- * Switch 1 :ON Switch 2: OFF setting (two button operations/ no function) will disable Touch-Motion function. Apply a different setting.

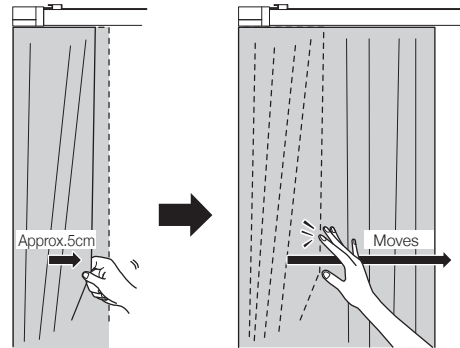

⚠ Caution

- ⚠ Always operate with the switch when you want to stop the curtain track. Forcibly pulling the curtain will cause damage.

<Rotation Direction Selecting>

- This function enables switching of motor rotation direction without reassembling the Rail Set. Use this if the Rail Set has been accidentally assembled in the reverse orientation.
- Turn Switch 4 ON, unplug the power cord, wait for at least 5 seconds, then plug the power cord in again.
- When you power on the product, the motor will rotate in the opposite (reverse) direction.
- Press the OPEN or CLOSE button to initiate instructive operation.

* For detailed information on instructive operation, refer to "Limit Setting Method" described on page 14.

■ Speed Setting Switch (sec./m)

- Switch for changing the opening/closing speed for the curtain.
- The speed setting switch are set by level "5" when the unit is delivered. (* speed changes by the weight of curtain.)

Speed level	1	2	3	4	5	6	7	8	9	A~F
Speed (sec./m)	11	10.5	10	9	8.5	8	7	6	5.5	4.5

<Acceleration Mode>

- This function is available only with 3 button switch.
- Press and hold the OPEN or CLOSE button for 3 seconds to accelerate opening/closing speed from set speed to the maximum speed (4.5 sec./m).
- Press switch in the same direction again to moving cancel accelerate mode and back to set speed.

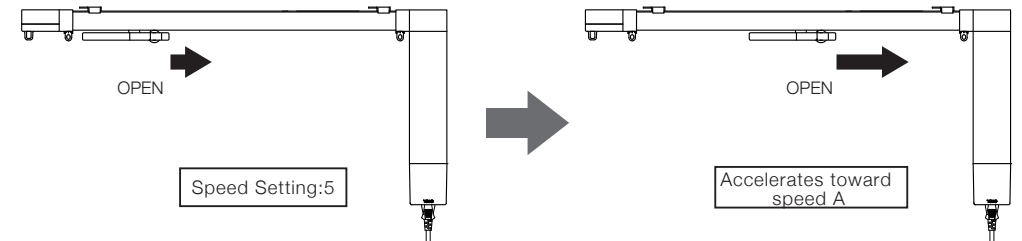

■ Address Setting Switch

- Switch for setting the address for infrared remote control (9ch).
- When using infrared remote control (9ch), set within the range of 1 to 9.
- The address setting switch are set by level "1" when the unit is delivered.

Address Setting Switch	1	2	3	4	5	6	7	8	9	A~F·0
Channel	1	2	3	4	5	6	7	8	9	—

* In case of FM remote control 2.4G, please refer to "Instruction Manual" of FM Receiver 2.4G and set the address.

Limit Setting

- When powered on, the system executes an instruction that automatically detects the full opening/closing position (Limit Position) of the curtain. Always confirm that this instruction is performed before use.

Limit Setting (instructive operation)

- 1 Switch the Motor Set ON.
- 2 Press the OPEN or CLOSE button of remote controller or button switch.
- 3 Pilot Roller will move in the full-closing direction and stop after reaching the full-closing position.
- 4 After stopping at the full-closing position, Pilot Roller automatically moves in the full-opening direction and stops at the full-opening position, thereby completing the instruction.

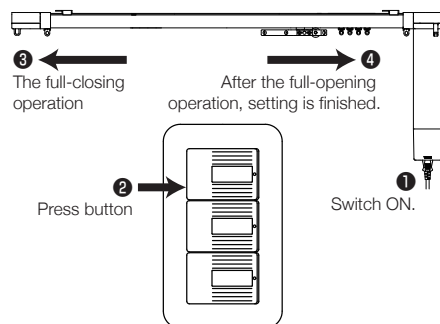

Caution

- ! Please always start the instruction with the curtain hanging condition.
- ! Be sure to run the instruction sequence with the motor set installed on the Rail Set. Note that Pilot Runner will move at the slowest speed while executing the command. This does not indicate an error or a defect.
- ! Please don't move curtains for 5 seconds after the instruction.
- ! If the process is interrupted in this way, issue the command once again. Note that the system will not recall the Limit Position if power is interrupted or the process is otherwise aborted while the command is being executed. (Once this command is completed, the Limit Position will be recalled even if power is interrupted.)

Intermediate Limit Setting

- Intermediate limits can be set for both the opening and closing directions. These can be set with the 3 button switch or infrared remote control; they cannot be set with the FM remote-control transmitter.

* Turn switch 1 of Function Setting of DIP Switch to OFF.

- 1 Press and hold the STOP button for 5 seconds to switch to intermediate limit setting mode.
- 2 Press and hold the OPEN or CLOSE button until the curtains reach the desired limit position.
- 3 If moving in the OPEN direction, press the STOP button 3 times and the OPEN button 1 time to set the intermediate limit position. If moving in the CLOSE direction, press the stop button 3 times and the CLOSE button 1 time to set the intermediate limit position.
- 4 Press the STOP button 5 times to end intermediate limit setting mode.

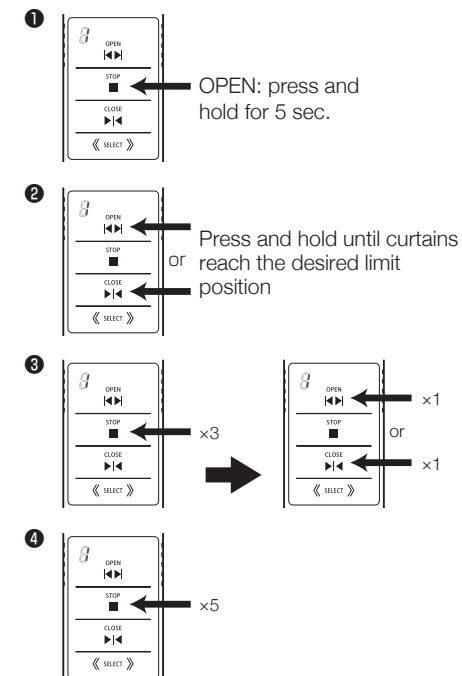

An initialization of Limit Setting

- The Limit Position can be set to assume a new value when curtains are replaced or in the event of another action.

- 1 Change the Address Setting Switch to "F" (refer to "Setting Method of the various switches" described on page 11).
- 2 Unplug the product.
- 3 Wait for at least 5 seconds after unplugging, then plug the power cord in again and power on the product. Limit settings have been reset.
- 4 Set the Address Setting Switch again to a preferred number (1-9).

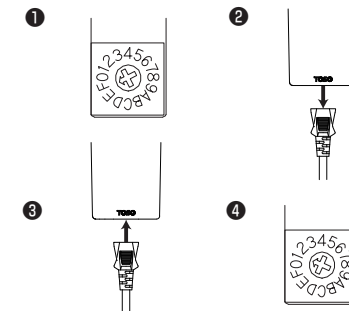

Check the Operation

- ① Switch the Motor Set ON.
- ② If you have not yet executed the instruction, do so now and set the Limit Position.
- ③ Operate using each switch and check the operation.

<Check the Operation with 3 Button Switch>

- ① To open and close the curtain, press the OPEN or CLOSE button.

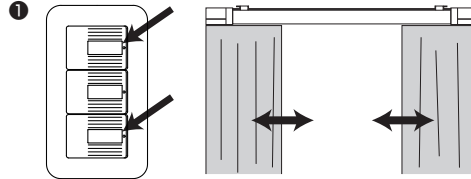

- ② To stop the curtain half way, press the STOP button.

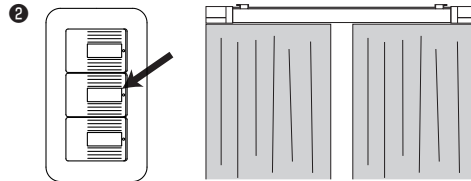

<Check the Operation with Infrared Remote Control (9ch)>

■ For operations in which the operating address is specified.

- ① Specify the Address No. registered for the product you want to operate.

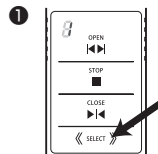

- ② To open and close the curtain, press the OPEN or CLOSE button.

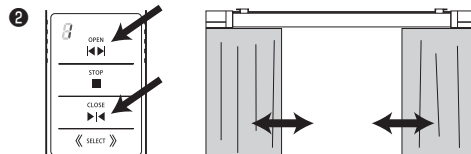

- ③ To stop the curtain half way, press the STOP button.

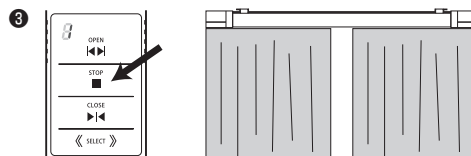

■ To execute an operation for all product addresses

- ① Specify ALL.

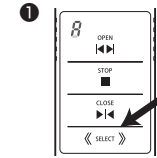

- ② To open and close the curtain, press the OPEN or CLOSE button.

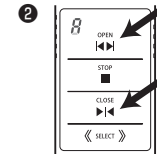

- ③ To stop the curtain half way, press the STOP button.

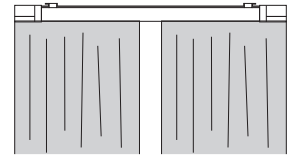
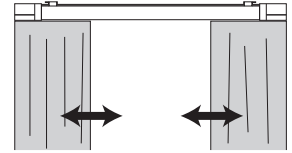
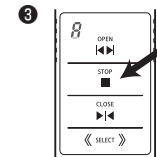

Caution

- ❗ The infrared remote control has orientation as illustrated, therefore be sure to point your remote control toward the infra-red receiver. Maximum distance to reach the radiation from the remote control to the receiver is 10 meter in radiation axis. Please note that when the radiation axis is not directly meeting the Receiver, radiation travels shorter distance.
- ❗ Because of characteristic as above, "ALL (A)" button is not available for opening /closing several motors at once. Please be sure to point your remote control toward the infra-red receiver that is connected to the motor you would like to open/close individually.
- ❗ Please do not mount infra-red receiver to shiny location. The infra-red receiver may not receive infra-red signal correctly if the receiver is mounted where it is exposed to direct sunshine or even shiny place where it is not exposed to direct sunshine.
- ❗ If the operation became unstable, please change the batteries.

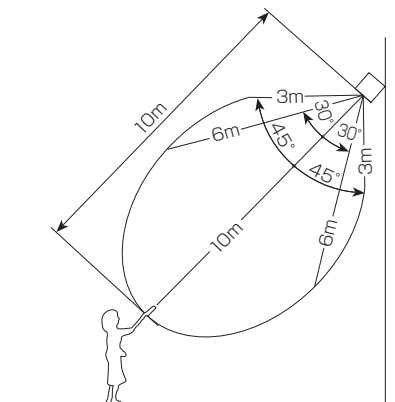

Product Specification

Progress Motor	25	50
Rated Power Voltage	AC 100 to 240V	
Rated Power Frequency	50/60Hz	
Power consumption	During stand by : 0.5W or lower , Max . load operation : 86W	
Operating voltage	DC24V	
Operating current	3 mA	
Power rating	0.86A (AC100V), 0.48A (AC240V)	
Rated Current	0.59N.m	0.98N.m
Time rating	8 min.(continuous operation)	
Ambient Temperature	0 to 50°C (non-condensing)	

Cleaning

- Whenever necessary, wipe the product with dry, clean, and soft cloth.
- Refrain from directly applying water, thinner or other chemicals to the product. Those materials may cause damages, discoloring, and distortion to the product.

Disposal of Packing Materials

- Do not leave packing material at the installation site.
- Separate combustible cardboard from noncombustible waste.
- Observe the local waster separation regulations when disposing of the materials.

Troubleshooting

■ Before you decide that the trouble is a malfunction, perform the following check.

Condition	Possible Causes and Solution
Not operating	● The power cord plug is not connected. ⇒Switch the Progress Motor Set to on (AC 100–240V).
	● The wire from the switch is not connected to the Motor Set. ⇒Refer to "Wiring Method" on page 6 and connect appropriately.
	● The Infra-red Receiver is not installed to enable remote control. ⇒Refer to "Wiring Method" on page 6 and connect appropriately.
	● Address of motor set is not correctly set. ⇒Refer to "Address Setting Switch" on page 13 and set the address.
	● In case of FM remote control, wiring from receiver 2.4G with IR terminal is connected to "SW". ⇒Connect to "IR".
	● In case of FM remote control, the receiver has no address setting. ⇒Refer to Instruction manual of FM Receiver and set the address.
	● No connection is in place between the interior wiring and the switch or the modular outlet. ⇒Refer to "Connection Method" on page 9 and connect appropriately.
	● In case of remote control, the battery is not in the FM transmitter. ⇒Install batteries in the transmitter.
Unstable operation	● Batteries are old. ⇒Replace old batteries with new batteries.
	● Inverter light is used near the Infra-red Receiver. ⇒Remove the Infra-red receiver from the inverter light.
	● Infra-red Receiver is under the sun light. ⇒Remove the Infra-red receiver to a location with no sun light.
	● There is an obstacle blocking the curtain. ⇒Remove the obstacle before the curtain in the opening/closing position.
	● Connection between the interior wiring and the switch or the modular outlet is loose. ⇒Refer to "Connection Method" on page 9 and connect appropriately.
Moves adversely and in opposite direction	● The rail is not assembled correctly. ⇒Set up according to "About Motor Rotation Direction Switching" on page 12.
	● The switches and interior wiring are not connected correctly. ⇒Exchange the red and green cables and reconnect.
	● The interior wiring and Modular outlet are not connected correctly. ⇒Exchange the red and green cables and reconnect.
	● The various setting switch No.4 is turned ON. ⇒Turn off the switch No.4.
Operation speed is low	● Opening/closing is set to the slowest speed. ⇒Refer to "Speed Setting Switch (sec./m)" on page 13 and change to a more suitable speed.
	● The instruction has not been completed. ⇒Refer to "Limit Setting Method" on page 14 and completely finish the Limit Setting Method (instructive operation)
Movement speed after having spent a power supply is low	● The Address Setting Switch is set to "F". ⇒Set the Address Setting Switch to a number between 1 and 9.
Operates only while pushing the button	● The value set here corresponds to two-button operations. ⇒Turn off the No.1 setting switch.
Curtain moves automatically when force opened manually.	● The various setting switch No.3 is turned on and Touch-motion functions is set. ⇒Turn off the switch.