

Selfie



- Designed to enable easy bending into a curve.
- Ready to be bent into L-shaped, S-shaped, U-shaped and other shaped curves.
- Special bender enables bending by hand at the installation site.

Selfie

Selfie's Unique Features and Applications

Curving flexibility.

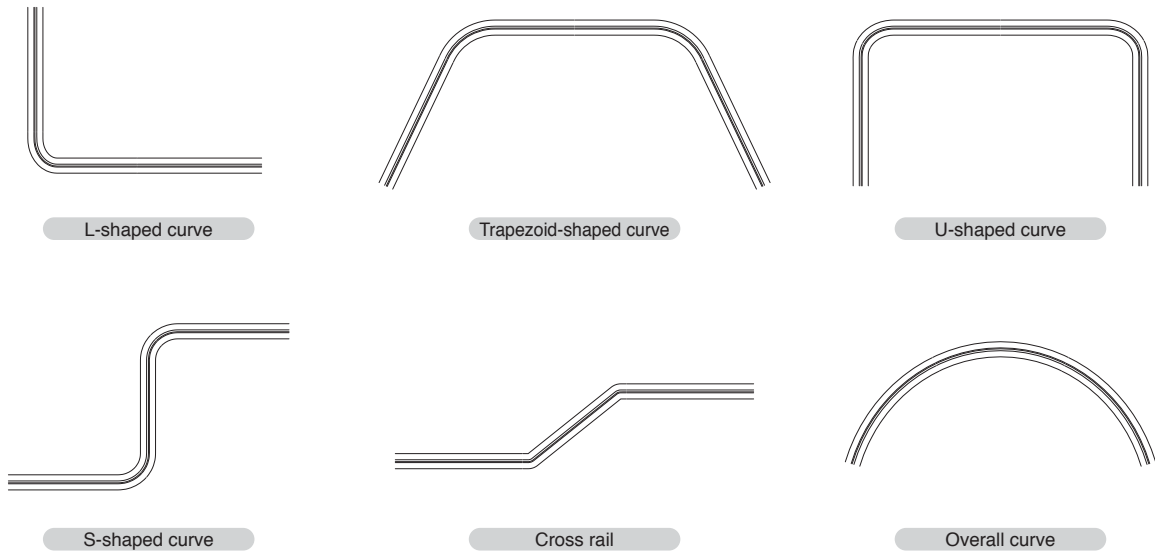

Smooth and quiet rollers.

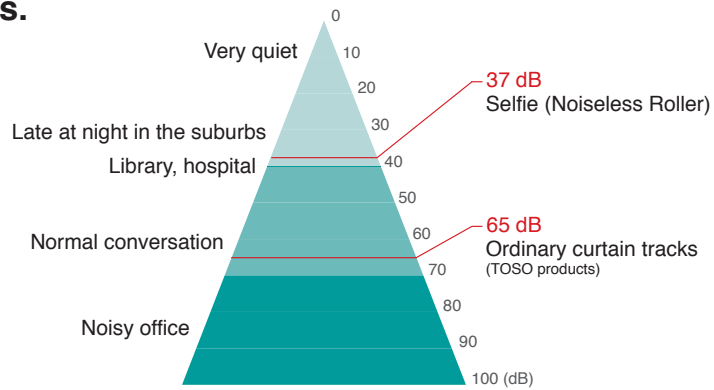

Exceptionally easy installation.

- The rail is vertically symmetrical and not direction-sensitive, resulting in easier, more efficient installation.
- The horizontally symmetrical I-shaped design makes the bend easy to undo.

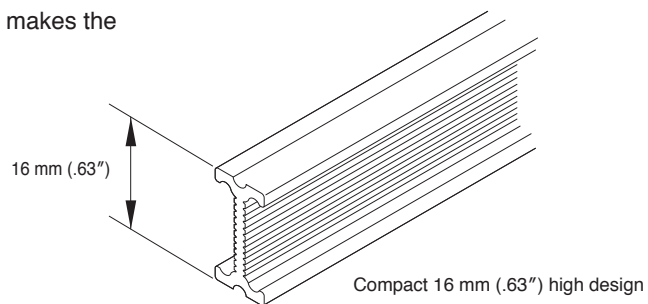

An easy way to stylish window treatment using the New Valance Rail.

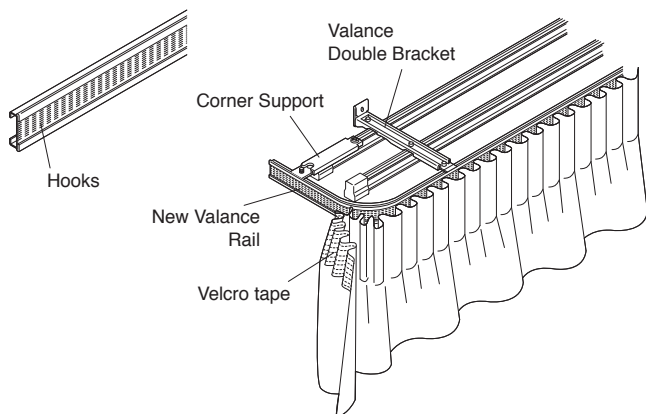

Velcro tape/pencil pleats



Velcro tape/smock pleats



When using as the New Valance Rail

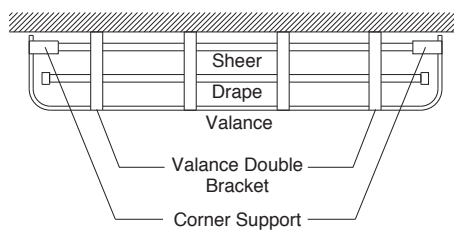

Using the bender enables easy curving.

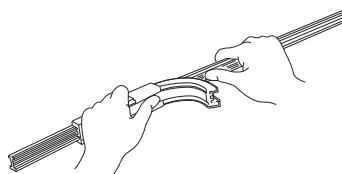

Use a joint pin at rail splices.

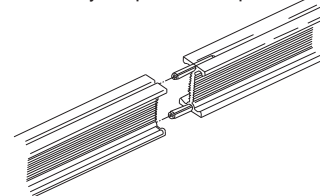

Use Intermediate Stop or Last-in Intermediate Stop for styled curtains.

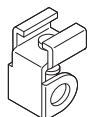

Intermediate Stop



Last-in Intermediate Stop

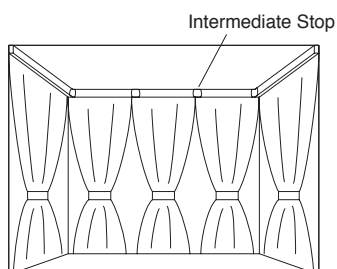

Selfie Last-in Intermediate Stop Installation Method

- Remain the screw loosened, fit the Last-in Intermediate Stop from underside of curtain rail as shown (①), turn it along with the rail and tighten the screw (②).

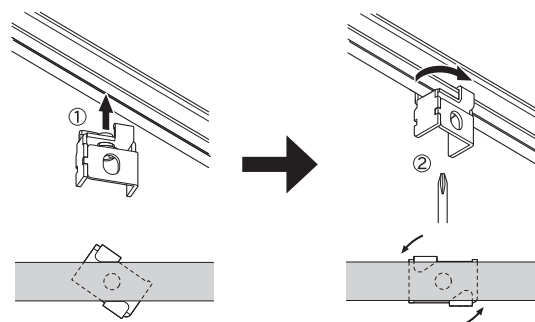

*View from above

Basic Installation Curving Method

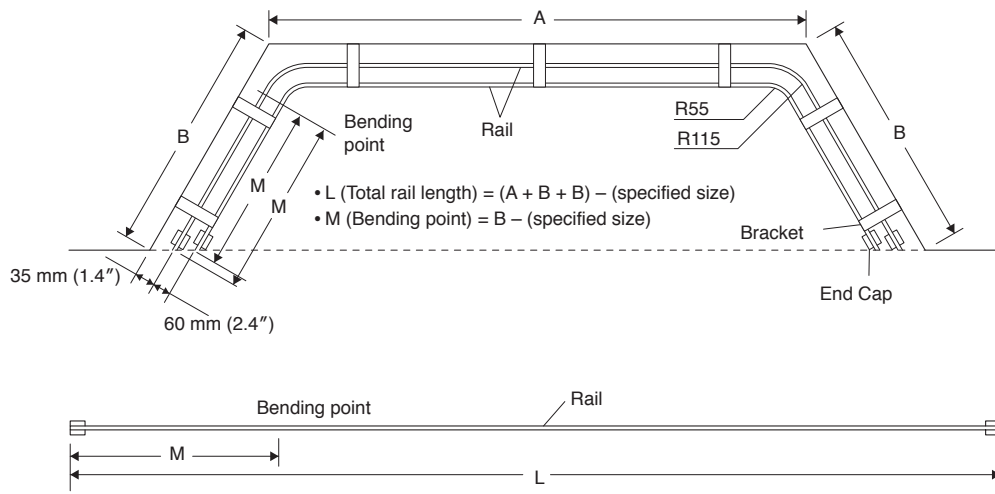

- At the rail bending point, align the 0° point of the bender with the end of the clamp and secure.
- Hold the bender and the rail and gradually bend the rail to the graduation mark of the desired angle.

Bending point: 0°

Window type	Attachment type		L (Total rail length)	M (Bending point)
90° bay window 	Single attachment	R115 use	$(A + B + B) - 239 \text{ mm (9.4")}$	$B - 150 \text{ mm (5.9")}$
		R55 use	$(A + B + B) - 187 \text{ mm (7.4")}$	$B - 90 \text{ mm (3.5")}$
	Double attachment	Exterior side (R115 use)	$(A + B + B) - 239 \text{ mm (9.4")}$	$B - 150 \text{ mm (5.9")}$
		Interior side (R55 use)	$(A + B + B) - 427 \text{ mm (16.8")}$	$B - 150 \text{ mm (5.9")}$
60° bay window 	Single attachment	R115 use	$(A + B + B) - 146 \text{ mm (5.7")}$	$B - 107 \text{ mm (4.2")}$
		R55 use	$(A + B + B) - 133 \text{ mm (5.2")}$	$B - 72 \text{ mm (2.8")}$
	Double attachment	Exterior side (R115 use)	$(A + B + B) - 146 \text{ mm (5.7")}$	$B - 107 \text{ mm (4.2")}$
		Interior side (R55 use)	$(A + B + B) - 341 \text{ mm (13.4")}$	$B - 142 \text{ mm (5.6")}$
45° bay window 	Single attachment	R115 use	$(A + B + B) - 138 \text{ mm (5.4")}$	$B - 97 \text{ mm (3.8")}$
		R55 use	$(A + B + B) - 133 \text{ mm (5.2")}$	$B - 72 \text{ mm (2.8")}$
	Double attachment	Exterior side (R115 use)	$(A + B + B) - 138 \text{ mm (5.4")}$	$B - 97 \text{ mm (3.8")}$
		Interior side (R55 use)	$(A + B + B) - 352 \text{ mm (13.9")}$	$B - 157 \text{ mm (6.2")}$

Using a Partial Bender

This is useful for making partial curves for curtain returns at both ends of a bay window curved rail to prevent light filtering into the room.

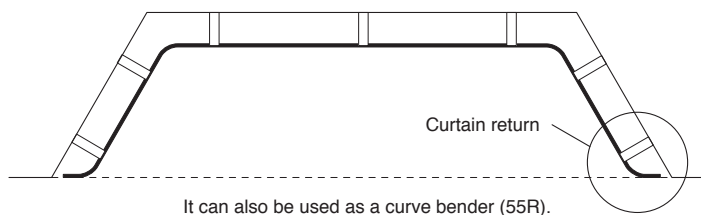

1. Insert the end of the rail into the bender.
2. Slowly bend the rail on your.

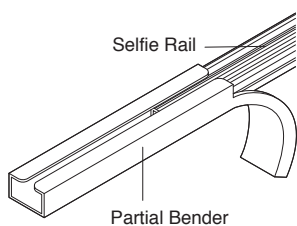

! Note: Do not use this bender with rails other than those specified.

Materials and Finishes

Parts	Material	Finish
Rail	Aluminum alloy extrusion material	Alumite, Alumite umber, Alumite white, Alumite warm white
Roller	Plate	Hard polyethylene
	Wheel	Acetal resin
	Oval ring	Stainless steel

Parts	Material	Finish
End Cap	Plate	Hard polyethylene
	Stop plate	Steel
	Oval ring	Stainless steel
Bracket	Body	Steel
	Snap board	Steel

Bracket Installation Interval and Allowable Curtain Load

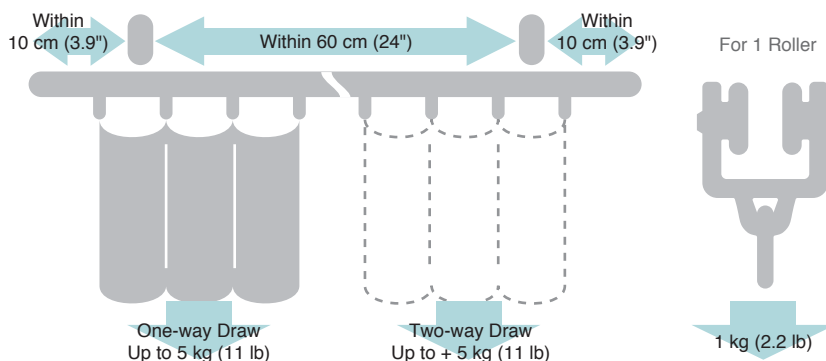

Installation Dimensions

Ceiling Attachment

Easy Snap Ceiling Single Bracket
Bracket width = 18 mm (.71")

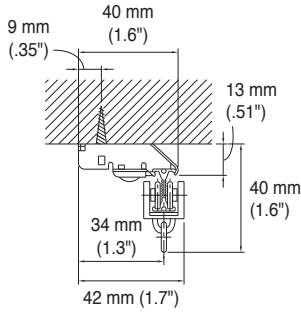

Ceiling Single Bracket
Bracket width = 14 mm (.55")

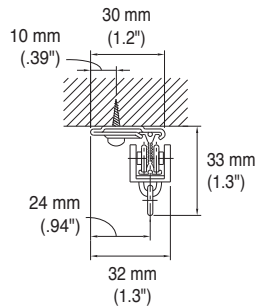

Easy Snap Ceiling Double Bracket
Bracket width = 19 mm (.75")

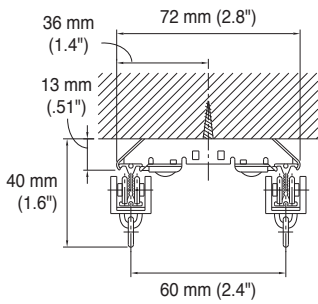

Ceiling Double Bracket
Bracket width = 18 mm (.71")

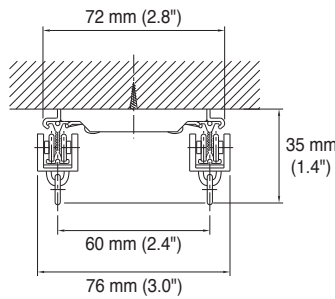

Last-in Intermediate Stop

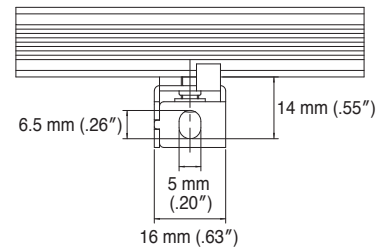

Wall Attachment

Single Bracket
Bracket width = 18 mm (.71")

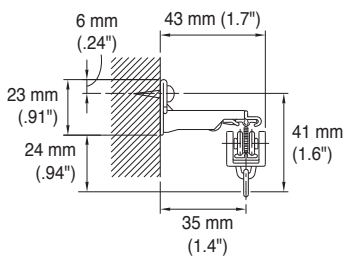

Double Bracket
Bracket width = 18 mm (.71")

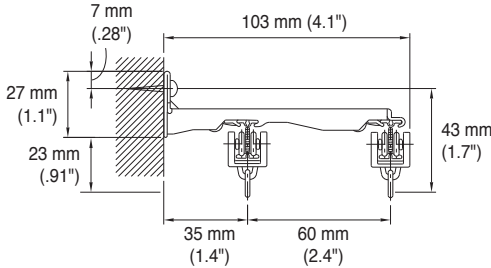

Extra Double Bracket
Bracket width = 24 mm (.94")

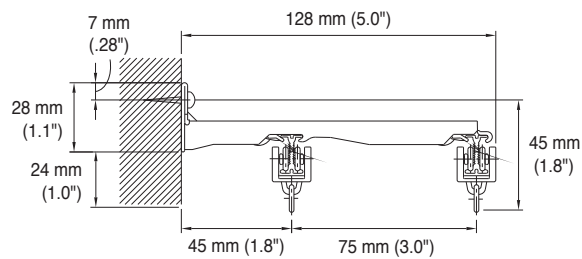

Valance Double Bracket
Bracket width = 18 mm (.71")

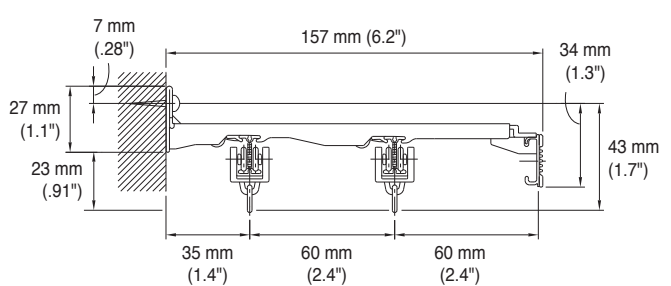

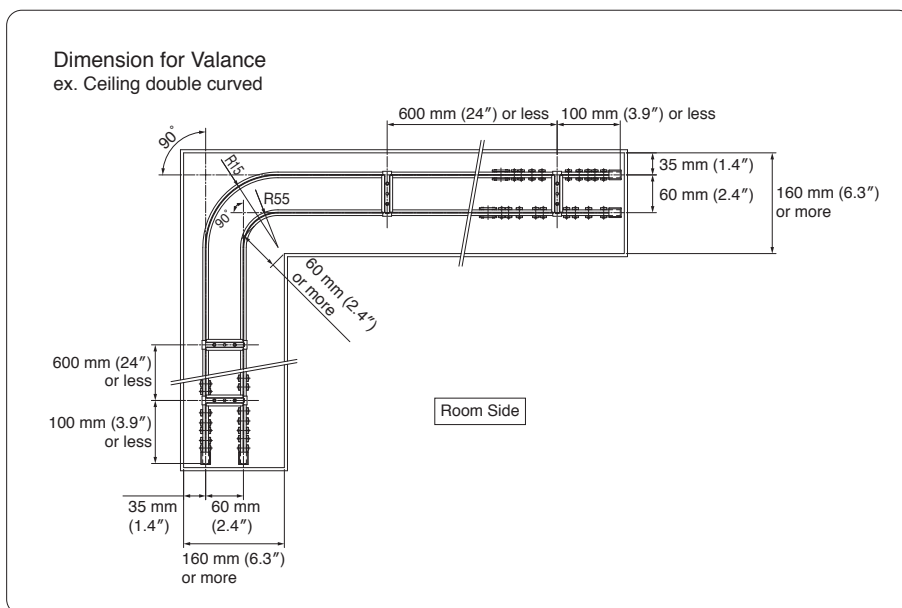

Selfie Rails



Size	Product Code			
	Silver	Umber	White	Warm white
1.82 m (72")	02330097	02330036	02330200	02330030
2.00 m (79")	02330098	02330037	02330201	02330031
2.73 m (107")	02330099	02330038	02330202	02330032
3.00 m (118")	02330100	02330039	02330203	02330033
3.64 m (143")	02330101	02330040	02330204	02330034
4.00 m (157")	02330102	02330041	02330205	02330035

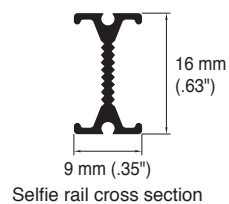

New Valance Rails

Warm white



Size	Product Code
	Warm white
2.37 m (93")	02330051
3.37 m (133")	02330052



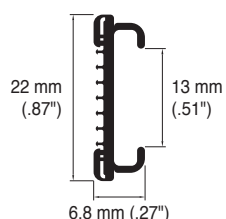







10 rails per box (not including separately manufactured rails)

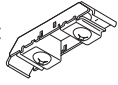





New Valance rail cross section with a Velcro (hooks)

Selfie Parts

Product Name		Product Code		
Roller (8 pieces per strip) 	Natural	02330107		
	Umber	02330019		
	Warm white	02330020		
MG Carrier 	Natural	02330108		
	Umber	02330021		
	Warm white	02330022		
One-way MG Carrier 	Natural	02330109		
	Umber	02330023		
	Warm white	02330024		
Noiseless Roller	Natural	30009780		
Noiseless MG Carrier	Natural	30009781		
Noiseless One-Way MG Carrier	Natural	30009782		
Single Bracket 	Silver	02330111		
	Umber	02330001		
	Warm white	02330002		
	Double Bracket 	Silver	02330112	
		Umber	02330003	
		Warm white	02330004	
Extra Double Bracket 	Silver	02330113		
	Umber	02330076		
	Warm white	02330077		
Valance Double Bracket	Warm White	02330006		

Product Name		Product Code		
Easy Snap Ceiling Single Bracket 	Silver	02330116		
	Umber	02330055		
	Warm white	02330054		
Ceiling Single Bracket 	Silver	02330114		
	Umber	02330007		
	Warm white	02330008		
Easy Snap Ceiling Double Bracket 	Silver	02330117		
	Umber	02330057		
	Warm white	02330056		
Ceiling Double Bracket 	Silver	02330115		
	Umber	02330009		
	Warm white	02330010		
Wall Bracket 	Silver	02330118		
	Umber	02330011		
	Warm white	02330012		
Overhead Hanger 	Silver	02330119		
	Umber	02330025		
	Warm white	02330026		
Corner Support	Warm White	02330014		
End Cap 	Natural	02330110		
	Umber	02330015		
	Warm white	02330016		
Last-in Intermediate Stop 			30010766	
	Intermediate Stop 	Natural	02330018	
		Joint Pin 		02330027

Product Name		Product Code	
Adjustable Hanger Rod B 	B400 (250-400 mm/ 9.8-16")	Umber	00290013
		White	00290026
	B700 (400-700 mm/ 16-28")	Umber	00290012
		White	00290025
Adjustable Hanger Rod A 	A170 (130-170 mm/ 5.1-6.7")	Silver	00290034
		White	00290038
		Warm white	00290035
	A250 (170-250 mm/ 6.7-9.8")	Silver	00290036
		White	00290039
		Warm white	00290037
	A400 (245-400 mm/ 9.6-16")	Silver	00290017
		White	00290040
		Warm white	00290030
	A700 (395-700 mm/ 16-28")	Silver	00290016
		White	00290041
		Warm white	00290031
A1100 (595-1,100 mm/ 23-43")	Silver	00290015	
	White	00290042	
	Warm white	00290032	
A1600 (845-1,600 mm/ 33-63")	Silver	00290014	
	White	00290043	
	Warm white	00290033	
Curve Bender 55R			02330028
Curve Bender 115R			02330029
Partial Bender			00950027