

# TOSO

---

## Roller Blind

---

# Mytec 01 Loop

## Double Type/Link Type/Link Double Type

---

No. R-120021E

First edition

---

## Instruction Manual

Thank you for purchasing TOSO products. To ensure safe use of this product, please read the following thoroughly and keep this manual stored.

### Guide for Distributors and Installation Contractors

This manual contains information for a user to safely operate this product.  
Please provide this manual to a customer.

## INDEX

■ Caution	2
■ Product View and Part Names	4
■ Installation Type	6
■ Installation and Detachment of a Double Type	6
■ Installation and Detachment of a Link Type	8
■ Installation and Detachment of a Link Double Type	11
■ How to Operate	15
■ How to Adjust the Screen Operation Force and the Ascent Speed	16
■ Fixing Improper Rolled up Screen	18
■ Troubleshooting	19
■ Cleaning	19

## Caution

\* This manual contains cautions and instructions for safe use of the product. Please read it carefully before using to ensure appropriate use.

- This document illustrates the dangers of using this product without taking necessary precautions. Please refer to the symbols below for different types of safety points.

 **Warning** Illustrates that if this product is misused, there are dangers of serious injuries or possible fatal accidents.

 **Caution** Illustrates that if this product is misused, there are dangers of casualties or possible physical damage of the product.

- This document illustrates safety points to be followed using the symbols below.

 Illustrates specific actions which are prohibited.



 Illustrates specific guidelines which must be followed.

## ■ Precautions upon installing the product (Please read before installation.)

### Warning

- ❗ Check the foundation base and strength of the material before installing this product. If not installed properly to the foundation base, there are dangers of it falling.
- ❗ Install this product as instructed with the necessary quantity of brackets. Otherwise the product may fall.





### Caution

-  This product is intended for indoor use. Please do not use it for outdoor purposes.
-  Locations subject to high temperatures and high humidity, or areas where water may leak, should be avoided.
- ❗ Make sure to install this product horizontally.
-  Do not grab the set bar to carry or lift this product. It may cause damage to the product.





## ■ Safety in Use (Please read thoroughly.)

### Warning

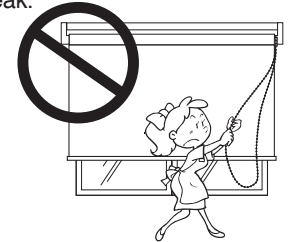
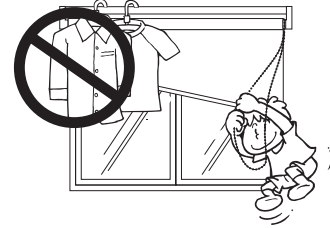

-  Please do not let children play with the cord or chain.
-  Please do not wrap the cord or chain around you, or allow it to get caught on something, because this may result in an accident.
- ❗ When not operating the product, tie the cord and chain at a height that is out of reach of small children.
-  Please do not hang from or pull on this product. This may damage the product or cause it to fall down.
-  Please do not operate the product abruptly or with unreasonable force. This may cause the product to fall down or break.

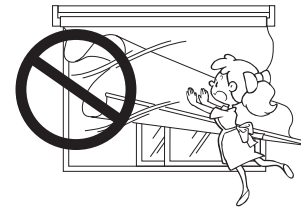

### Caution

-  When there is a strong wind, either close the window or have the Screen completely rolled up.
-  Please do not dismantle the mechanical assembly nor lubricate the moving parts of this product. This will ensure physical damage or malfunction of the product.
-  Please do not use it by open flames.



-  Be sure to grasp the pull cord or the ball chain to operate the blind. Do not operate it by grasping the screen, roller pipe or weight bar.
-  Do not place an object that is liable to break or an object that is likely to interfere with the operation of the product, inside the range of the opening and closing operation.
- ❗ Use the product within the specified height range. If you use it outside this range, the screen may fall down or break.

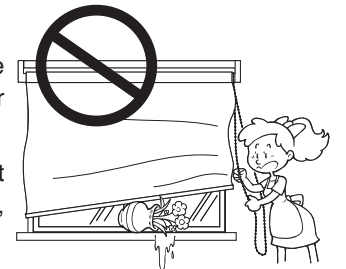

## Product View and Part Names

### Double Type

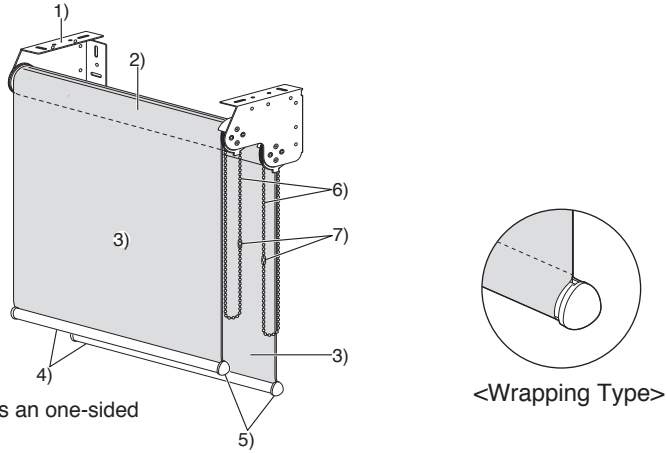

\* The figure shows an one-sided operation (right).

#### Component

1) Double Bracket	4) Weight Bar	7) Ball Chain Connector
2) Roller Pipe	5) Weight Bar Cap	
3) Screen	6) Ball Chain	

### Link Type

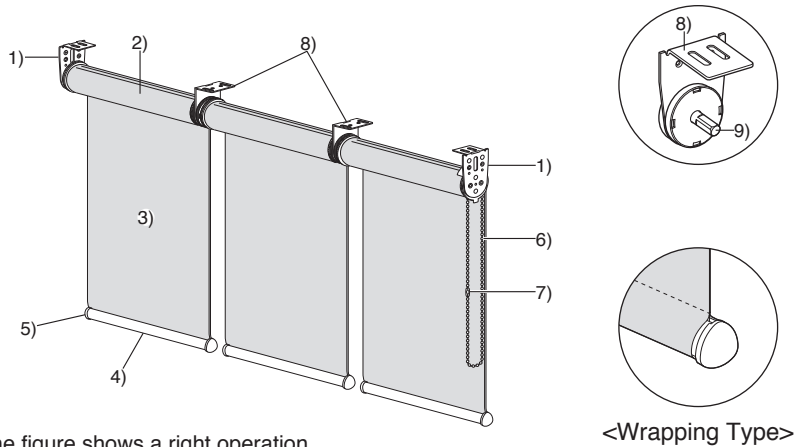

\* The figure shows a right operation.

#### Component

1) Side Holder	4) Weight Bar	7) Ball Chain Connector
2) Roller Pipe	5) Weight Bar Cap	8) Link Bracket
3) Screen	6) Metal Ball Chain	9) Link Joint Pin

\* Regarding the size of Side Holder and Link Bracket differs depending on the size of product and the specifications of the screen.

### Link Double Type

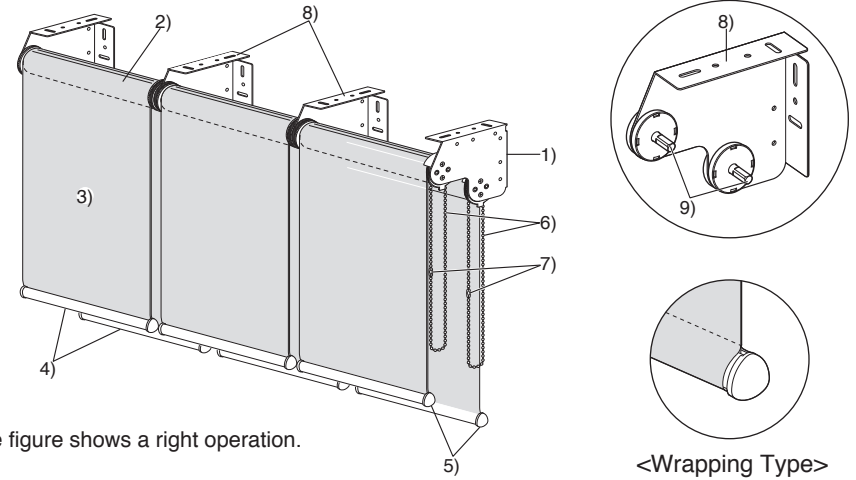

\* The figure shows a right operation.

#### Component

1) Double Bracket	4) Weight Bar	7) Ball Chain Connector
2) Roller Pipe	5) Weight Bar Cap	8) Link Double Bracket
3) Screen	6) Metal Ball Chain	9) Link Joint Pin

### Accessories

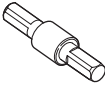
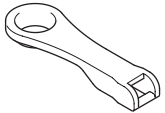
Component		Link Joint Pin *1	Winder *2
			
Product Width [mm]	2-unit	1 piece	1 piece
	3-unit	2 pieces	
Link Type	2-unit	2 pieces	
	3-unit	4 pieces	
Double Type		—	

\*1 Used with a link type or a link double type.

\*2 Keep carefully together with the instruction manual.

### Optional Parts

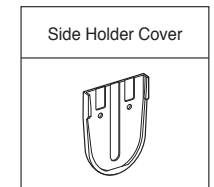

\* Used only with a link type.

## Installation Type

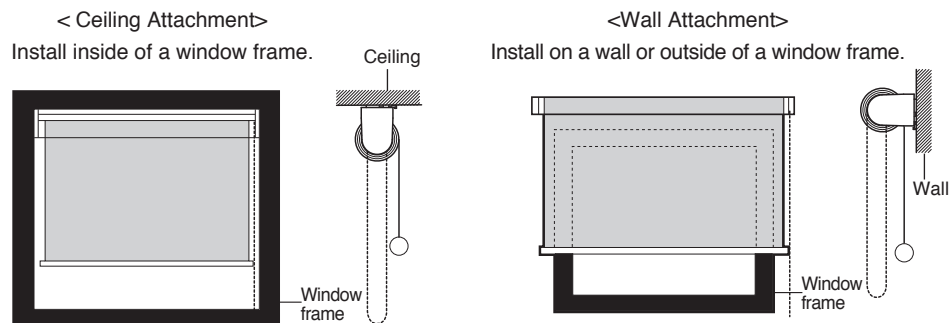

## Installation and Detachment of a Double Type

- (1) Determine the installation locations of the brackets so that the distance between the brackets is the same as the width of the product that you ordered.

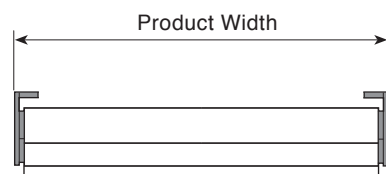

- (2) Mount Double Brackets with screws.

### Caution

- Use fixing screws that are suitable for the strength and the material of the wall or window frame to which the brackets are to be fixed.

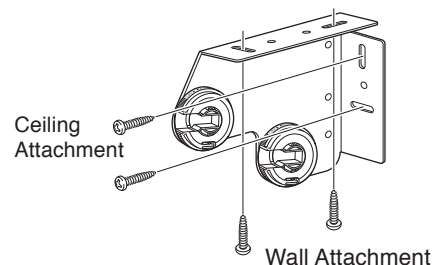

- (3) Install the screen.

- The method of lowering the roll screen differs depending upon whether it is installed on the window side or the room side.
- The figure shows an one-sided operation (right).

- 1) Pull down the screen 5 to 10 cm, then set the chain as the position of Chain Connector is located on the rear side, then attach Chain Connector is about 3 cm below Bottom Bar. The direction of the chain which of the screen installed on the room side is the opposite of the above.

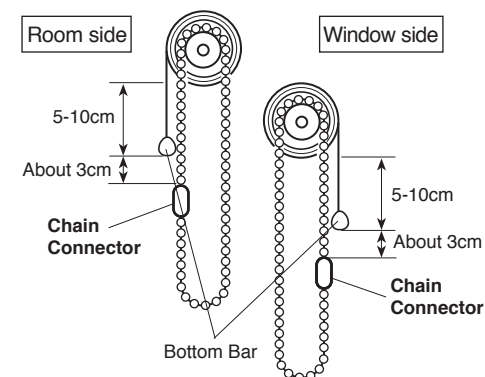

- 2) Insert the dowel (transparent) at the end of the screen into Side Holder on the chain side.

- Do not install the both screens at once.
- The position of Side Holder on the chain side differs depending upon the operating position.

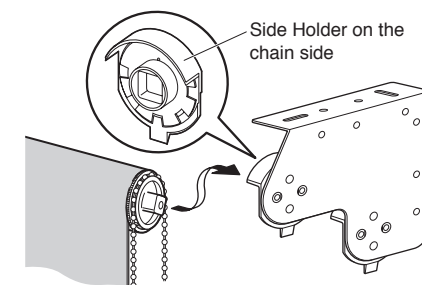

- 3) Install the black knob on the roll screen body onto Side Holder on the opposite side the chain as the red part can be seen at the front. Once the screen is correctly in place, turn the dial in the "CLOSE" direction until it clicks.

- Install the screens one at a time, and check to see if they are parallel to each other.

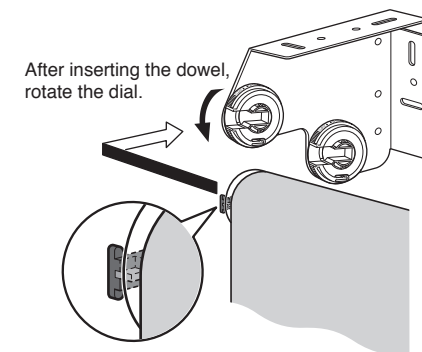

- (4) Finally, open and close the screen two or three times, and check their operation.

- (5) How to remove the screen

- Pull down the screen 5 and 10 cm and stop it.
  - Rotate the dial of Side Holder on the opposite side the chain until it stops in the "OPEN" direction.
  - Remove a roll screen body slowly with both hands. Also, take care that the chain does not drop.
- Do not remove the both screens at once.

## Installation and Detachment of a Link Type

(1) Determine the installation locations of the brackets so that the distance between the brackets is the same as the width of the product that you ordered. The direction of each Link Bracket is shown below.

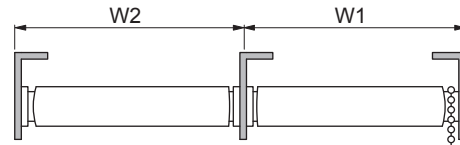

\* The illustration applies to a ceiling attachment. In the case of a wall attachment type, install the brackets on the wall using the same procedure.

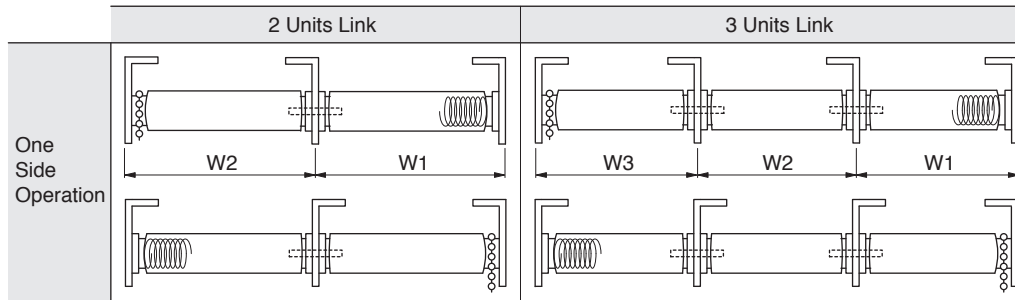

\* For right operation, install the brackets on the left side as the part shown at right.

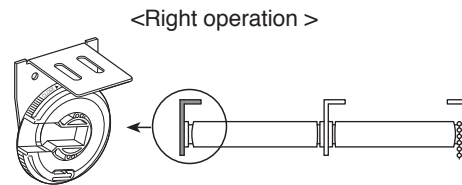

\* For left operation, install the brackets on the right side as the part shown at right.

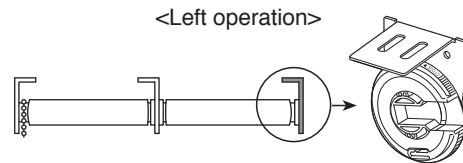

(2) Mount End Side Brackets with screws.

If you install the brackets while they are bent, the screens are liable to move sluggishly or drop off.

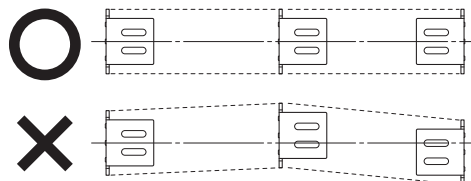

### Caution

Use fixing screws that are suitable for the strength and the material of the wall or window frame to which the brackets are to be fixed. Be sure to install each Side Holder using at least two fixing screws.

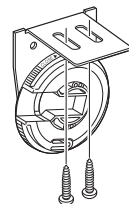

(3) Install the screen.

\* The illustration applies to a ceiling-attachment type (right operation).

### Caution

Install the screen from the chain side. Use the following sequence otherwise you will be unable to install the screen.

1) Remove the cover of each Link Bracket (other than Side Holders at both ends) on the side opposite the chain.

2) Pull down the screen 5 to 10 cm, then set the chain as the position of Chain Connector is located on the rear side, then attach Chain Connector is about 3 cm below Bottom Bar.

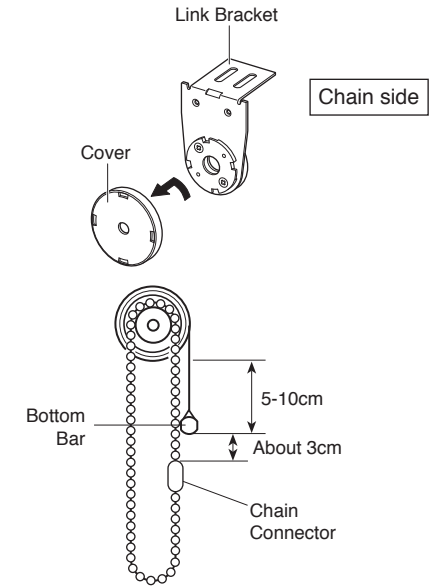

3) Insert the dowel (transparent) on the end of the screen into Side Holder (right side).

\* For left operation, insert the dowel into Side Holder on the left side.

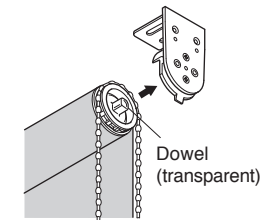

4) While holding the screen, insert Link Joint Pin into Link Bracket, and then pass it through the hole in the roll screen body side. Once you have inserted Link Joint Pin to the rear, install the cover while rotating it.

\* After installing the cover, check to see if it has been tightened securely.

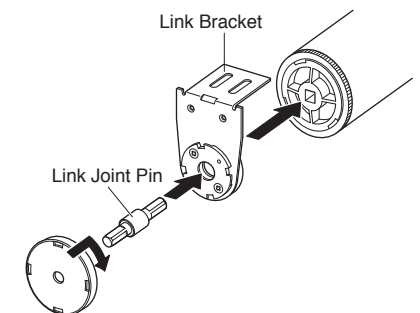

5) Install the screen on the opposite side the chain. Fit the hole in the roll screen body over Link Joint Pin protruding from Link Bracket.

\* In the case of three links, repeat the work of steps 4) and 5).

\* Install the screens as of they are the same height.

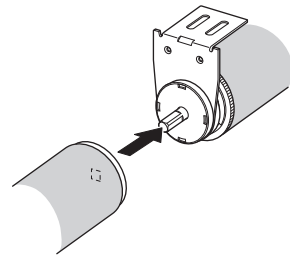

6) Install the black knob on the roll screen body to Side Holder (left side) to ensure that the red part is visible at the front. Once the screen is correctly in place, turn the dial in the "CLOSE" direction until it clicks.

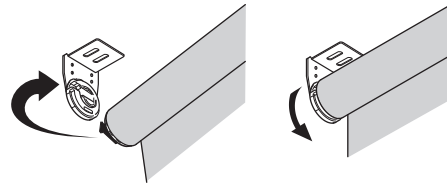

7) Set Ball Chain cover at the top.

\* Push the tab on the ball chain cover to the side opposite the screen, and while keeping it pressed, turn the cover through 90°.

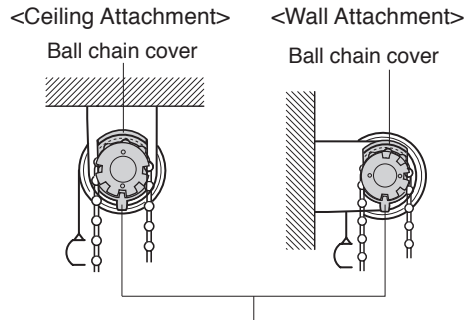

(4) Finally, open and close the screen two or three times, and check their operation.

(5) How to remove the screen

1) Pull down the screen 5 and 10 cm and stop it.

2) Rotate the dial of Side Holder on the opposite side the chain until it stops in the "OPEN" direction.

3) Remove a roll screen body slowly with both hands. Remove the cover and Link Joint Pin of the link section, and then remove the screen, while taking care that neither the screen nor the chain drops.

## Installation and Detachment of a Link Double Type

(1) Determine the installation locations of the brackets so that the distance between the brackets is the same as the width of the product that you ordered. The direction of each Link Bracket is shown below.

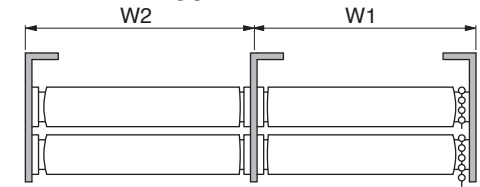

	2 Units Link	3 Units Link
Both Sides Operation		
One Side Operation		

(2) Mount End Side Brackets with screws.

If you install the brackets while they are bent, the screens are liable to move sluggishly or drop off.

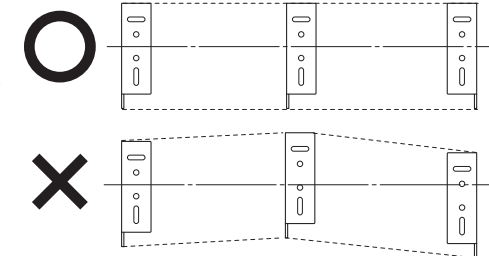

### Caution

Use fixing screws that are suitable for the strength and the material of the wall or window frame to which the brackets are to be fixed. Be sure to install each Side Holder using at least two fixing screws.

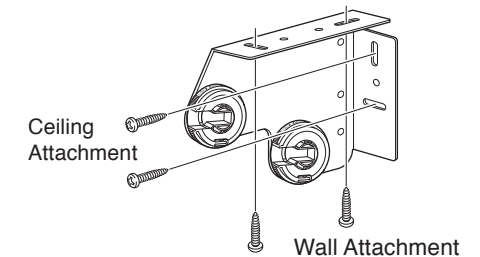



(3) Install the screen.

- \* The method of lowering the roll screen on the window side differs from that of the roll screen on the room side.
- \* The figure shows an one-sided operation (right).

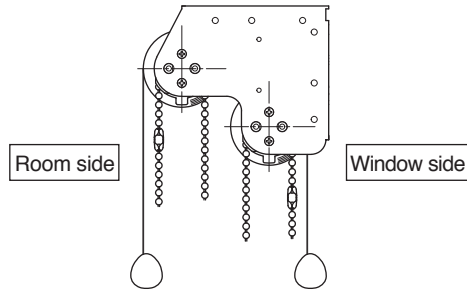

**Caution**

! Install the screen from the chain side. Use the following sequence otherwise you will be unable to install the screen.

1) Remove the cover of each Link Double Bracket (other than Side Brackets at both ends) on both the chain side and the side opposite it.

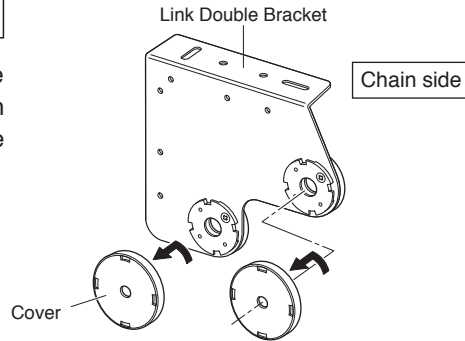

2) Pull down the screen 5 to 10 cm, then set the chain as the position of Chain Connector is located on the rear side, then attach Chain Connector is about 3 cm below Bottom Bar. The direction of the chain which of the screen installed on the room side is the opposite of the above.

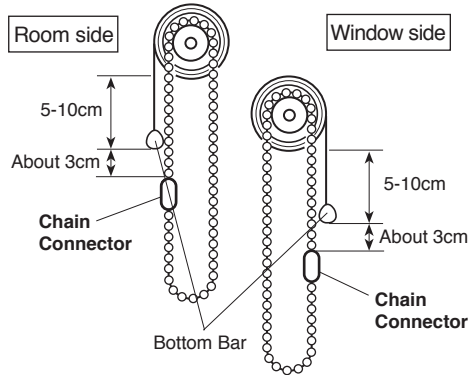

3) Insert the dowel (transparent) at the end of the screen into Side Holder on the chain side.

- \* Do not install some screens at once.
- \* The position of Side Holder on the chain side differs depending upon the operating position.

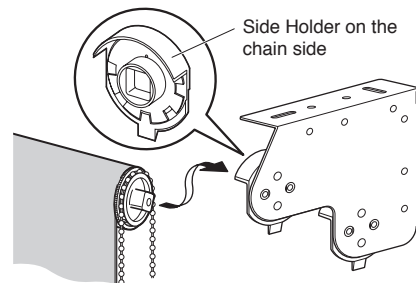

4) While holding the screen, insert Link Joint Pin into Link Bracket, and then pass it through the hole in the roll screen body side. Once you have inserted Link Joint Pin to the rear, install the cover while rotating it.

- \* After installing the cover, check to see if it has been tightened securely.
- \* Do not install some screens at once.

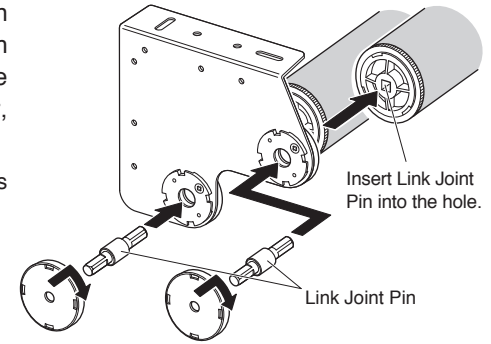

5) Remove the screen on the side opposite the chain. Fit the hole in the roll screen body over Link Joint Pin protruding from Link Double Bracket.

- \* In the case of three links, repeat the work of steps 4) and 5).
- \* Install the screens as of they are the same height.

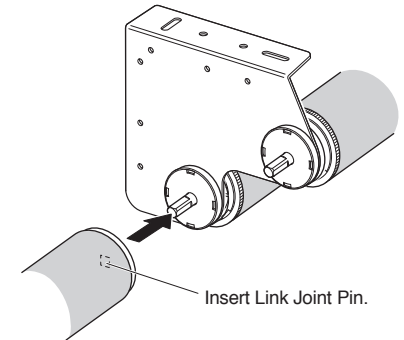

6) Install the black knob on the roll screen body onto Side Holder on the opposite side the chain as the red part can be seen at the front. Once the screen is correctly in place, turn the dial in the "CLOSE" direction until it clicks.

- \* Check to see if Roller Pipes are parallel to each other.

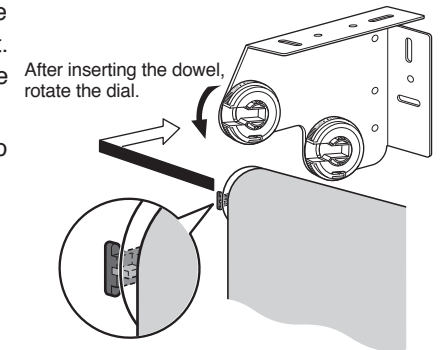

(4) Finally, open and close the screen two or three times, and check their operation.

(5) How to remove the screen

- 1) Pull down the screen 5 and 10 cm and stop it.
- 2) Rotate the dial of Side Holder on the opposite side the chain until it stops in the "OPEN" direction.
- 3) Remove a roll screen body slowly with both hands. Remove the cover and Link Joint Pin of the link section, and then remove the screen, while taking care that neither the screen nor the chain drops.

\* Remove the screens one at a time.

## How to Operate



### Caution

- ❗ Make sure to pull Ball Chain slowly when using the product. If Ball Chain is pulled quickly, the product may not roll up properly.
- ⊘ Please do not hang from Screen or Ball Chain. The product may fall down.

### <Installation and Detachment of a Double Type / Link Double Type>

#### ■ How to close a screen

- To lower the screen on the room side, pull down the front Ball Chain.
- To lower the screen on the window side, pull down the rear Ball Chain.

#### ■ How to open a screen

- To raise the screen on the room side, pull down the rear Ball Chain.
- To raise the screen on the window side, pull down the front Ball Chain.

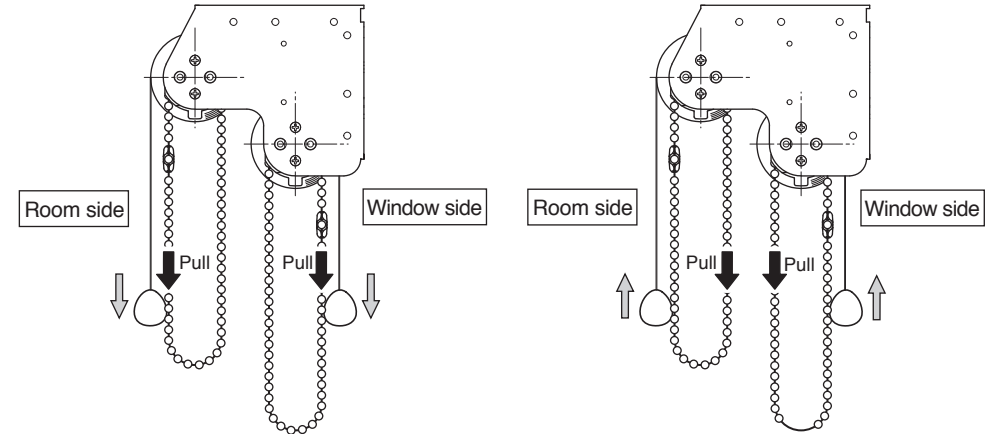

### <Link Type>

#### ■ How to close a screen

- Pull the back side of Ball Chain downward.

#### ■ How to open a screen

- Pull the front side of Ball Chain downward.

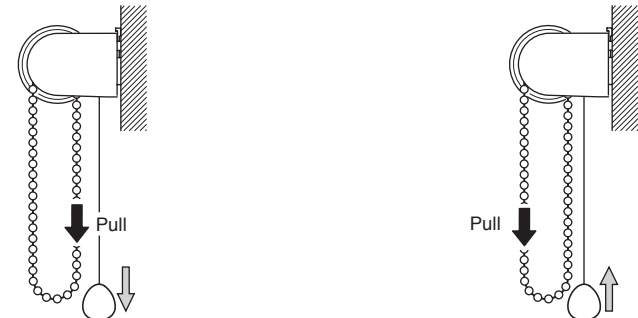



## How to Adjust the Screen Operation Force and the Ascent Speed

(1) Remove the screen.

\* To remove the screen, refer to the removal method that corresponds to the specifications of the screen.

(2) Align Winder (provided with the blind) with the black knob on the screen that you removed. In the case of the following product types, carry out adjustment according to the types.

\* In the case of a link type / double link type, adjust the screen on the side opposite the chain.

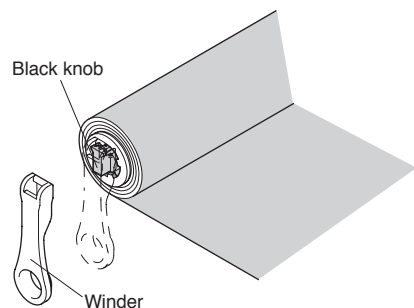

<Link type right operation>

<Double type (window side screen) right operation>

<Link double type (window side screen) right operation>

<Double type (room side screen) left operation>

<Link double type (room side screen) left operation>

■ Lighter roll up

- Turn Winder 1-2 times clockwise while pulling Winder as directed and unlocking the speed.

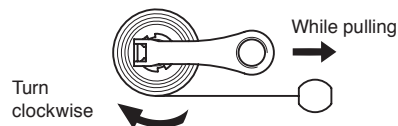

■ Heavier roll up

- Turn Winder 1-2 times counter-clockwise while pulling Winder as directed and unlocking the speed.

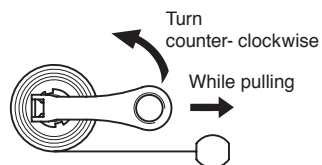

<Link type left operation>

<Double type (window side screen) left operation>

<Link double type (window side screen) left operation>

<Double type (room side screen) right operation>

<Link double type (room side screen) right operation>

■ Lighter roll up

- Turn Winder 1-2 times counter-clockwise while pulling Winder as directed and unlocking the speed.

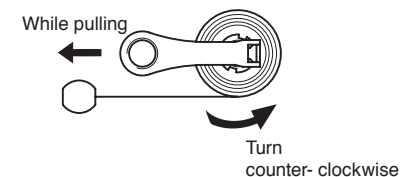

■ Heavier roll up

- Turn Winder 1-2 times clockwise while pulling Winder as directed and unlocking the speed.

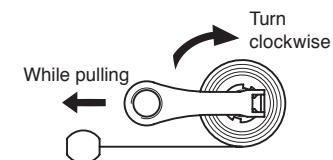

### Caution

- ❗ Winder does not turn if not pulled to unlock direction as illustrated.
- ⊘ Do not turn more than twice at once.
- ❗ Hold Winder securely especially while pulling to unlock direction. If Winder is released while pulled to unlock direction, Roller Pipe blows off Winder, and it may cause accidents or injuries.

(3) To install the screen, refer to the installation method that corresponds to the specifications of the screen

## Fixing Improper Rolled up Screen

- When a screen is not rolled up properly, it may cause damages to the screen or the product. TOSO Roller Blinds are inspected and adjusted to operate properly when delivered, however if a roller blind rolls improperly, follow below instruction.

### <What is Improper Rolling?>

- 1) Screen edge is misaligned.
- 2) Screen edge touches a side holder.
- 3) Weight Bar is not horizontal.

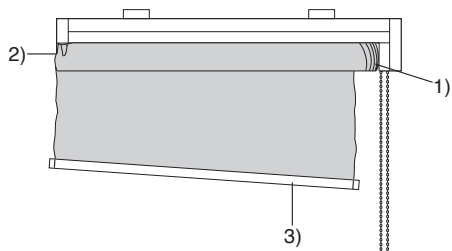

### How to fix improper rolling?

- (1) Make sure a product is installed correctly.

- 1) Is a product installed horizontally?
- 2) Are Brackets placed at correct at position?

- \* Reinstall the product if it is not installed properly.

- (2) Slowly operate Ball Chain and pull down the screen to the bottom, then once again roll up the screen.

- (3) Repeat the instruction (2) for 2-3 times.

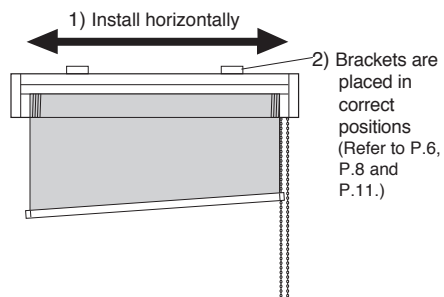

## Troubleshooting

Phenomenon	Actions
<ul style="list-style-type: none"> <li>● When the screen does not stop at the desired height, and rolls down.</li> </ul>	<ul style="list-style-type: none"> <li>● Repeatedly carry out the adjustment described in "Lighter roll up" on P.16 or P.17.</li> </ul>
<ul style="list-style-type: none"> <li>● When the screen does not stop at the desired height, and rolls up.</li> </ul>	<ul style="list-style-type: none"> <li>● Repeatedly carry out the adjustment described in "Heavier roll up" on P.16 or P.17.</li> </ul>
<ul style="list-style-type: none"> <li>● When Ball Chain is pulled, it does not operate smoothly with an unusual noise, or does not operate at all.</li> </ul>	<ul style="list-style-type: none"> <li>● It is likely that the position of Ball Chain Cover is incorrect. Carry out the procedure set out on P.10.</li> </ul>
<ul style="list-style-type: none"> <li>● When the screen does not descend</li> </ul>	<ul style="list-style-type: none"> <li>● It is likely that this is because the dial of Side Holder is not fully in the "CLOSE" condition. Turn the dial in the "CLOSE" direction until it stops completely.</li> </ul>



### Caution

- ⊘ Do not disassemble or modify the mechanism inside Roller Pipe.

## Cleaning

- For regular care, dust with a feather duster or a hand mop.
- To avoid discoloration, avoid cleaning the screen with water or using it in a location susceptible to splashing water.