

Selfie



- Designed to enable easy bending into a curve.
- Ready to be bent into L-shaped, S-shaped, U-shaped and other shaped curves.
- Special bender enables bending by hand at the installation site.

Selfie

Selfie's Unique Features and Applications

An easy way to stylish window treatment using the New Valance Rail.

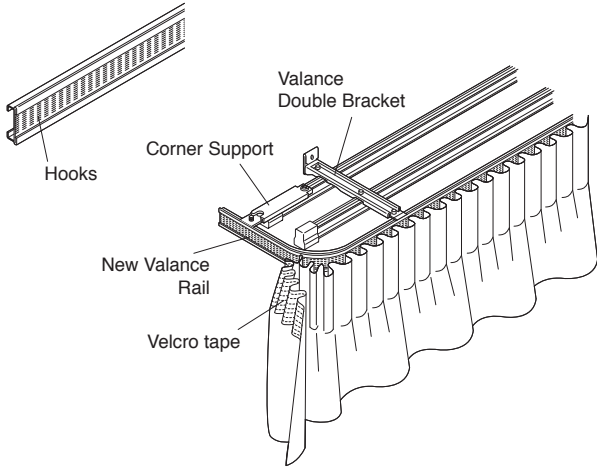

Velcro tape/pencil pleats



Velcro tape/smock pleats



When using as the New Valance Rail

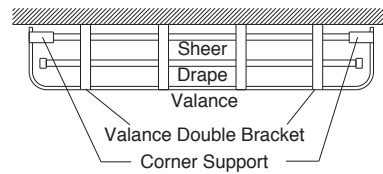

Using the bender enables easy curving.

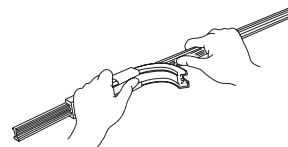

Use a joint pin at rail splices.

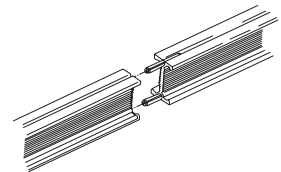

Exceptionally easy installation.

- The rail is vertically symmetrical and not direction-sensitive, resulting in easier, more efficient installation.
- The horizontally symmetrical I-shaped design makes the bend easy to undo.

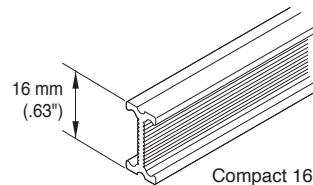

Compact 16 mm (.63") high design

Curving flexibility.

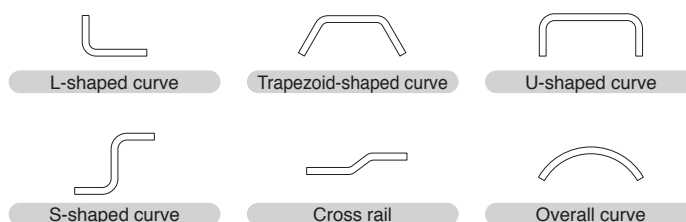

Use intermediate stops for styled curtains.

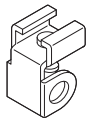

Intermediate stop

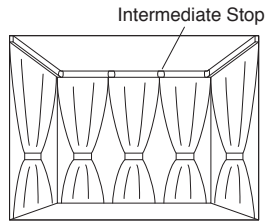

Basic Installation Curving Method

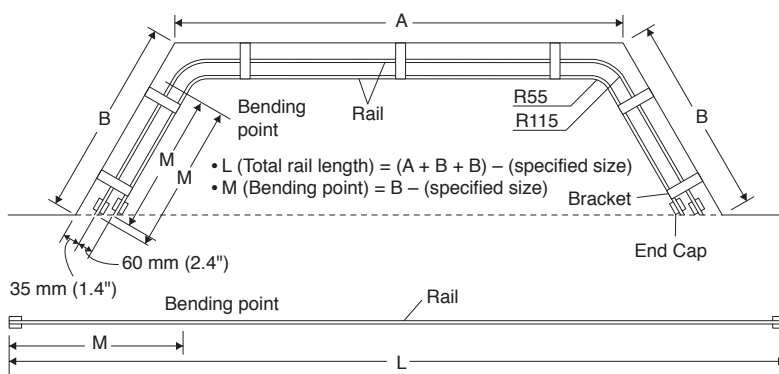

1. At the rail bending point, align the 0° point of the bender with the end of the clamp and secure.

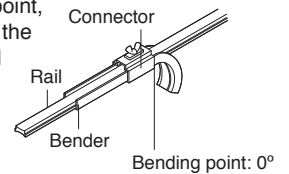

2. Hold the bender and the rail and gradually bend the rail to the graduation mark of the desired angle.

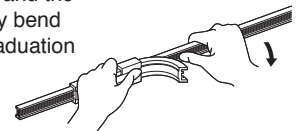

| Window type | Attachment type | L (Total rail length) | M (Bending point) | |
|--------------------|-------------------|--------------------------|----------------------------------------|-----------------------------|
| 90° bay window | Single attachment | R115 use | $(A + B + B) - 239 \text{ mm (9.4")}$ | $B - 150 \text{ mm (5.9")}$ |
| | | R55 use | $(A + B + B) - 187 \text{ mm (7.4")}$ | $B - 90 \text{ mm (3.5")}$ |
| | Double attachment | Exterior side (R115 use) | $(A + B + B) - 239 \text{ mm (9.4")}$ | $B - 150 \text{ mm (5.9")}$ |
| | | Interior side (R55 use) | $(A + B + B) - 427 \text{ mm (16.8")}$ | $B - 150 \text{ mm (5.9")}$ |
| 60° bay window | Single attachment | R115 use | $(A + B + B) - 146 \text{ mm (5.7")}$ | $B - 107 \text{ mm (4.2")}$ |
| | | R55 use | $(A + B + B) - 133 \text{ mm (5.2")}$ | $B - 72 \text{ mm (2.8")}$ |
| | Double attachment | Exterior side (R115 use) | $(A + B + B) - 146 \text{ mm (5.7")}$ | $B - 107 \text{ mm (4.2")}$ |
| | | Interior side (R55 use) | $(A + B + B) - 341 \text{ mm (13.4")}$ | $B - 142 \text{ mm (5.6")}$ |
| 45° bay window | Single attachment | R115 use | $(A + B + B) - 138 \text{ mm (5.4")}$ | $B - 97 \text{ mm (3.8")}$ |
| | | R55 use | $(A + B + B) - 133 \text{ mm (5.2")}$ | $B - 72 \text{ mm (2.8")}$ |
| | Double attachment | Exterior side (R115 use) | $(A + B + B) - 138 \text{ mm (5.4")}$ | $B - 97 \text{ mm (3.8")}$ |
| | | Interior side (R55 use) | $(A + B + B) - 352 \text{ mm (13.9")}$ | $B - 157 \text{ mm (6.2")}$ |

Using a Partial Bender

This is useful for making partial curves for curtain returns at both ends of a bay window curved rail to prevent light filtering into the room.

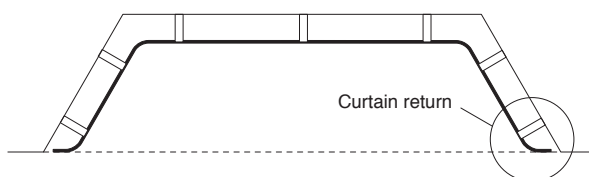

It can also be used as a curve bender (55R).

1. Insert the end of the rail into the bender.

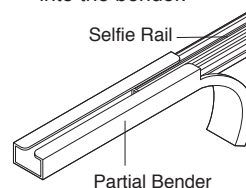

2. Slowly bend the rail on your.



⚠ Note: Do not use this bender with rails other than those specified.

Materials and Finishes

| Parts | Material | Finish |
|--------|-----------------------------------|---------------------------------------|
| Rail | Aluminum alloy extrusion material | Alumite, Alumite umber, Alumite white |
| Roller | Plate | Hard polyethylene |
| | Wheel | Acetal resin |
| | Oval ring | Stainless steel |

| Parts | Material | Finish |
|---------|------------|-------------------|
| End Cap | Plate | Hard polyethylene |
| | Stop plate | Steel |
| | Oval ring | Stainless steel |
| Bracket | Body | Steel |
| | Snap board | Steel |

Bracket Installation Interval and Allowable Curtain Load

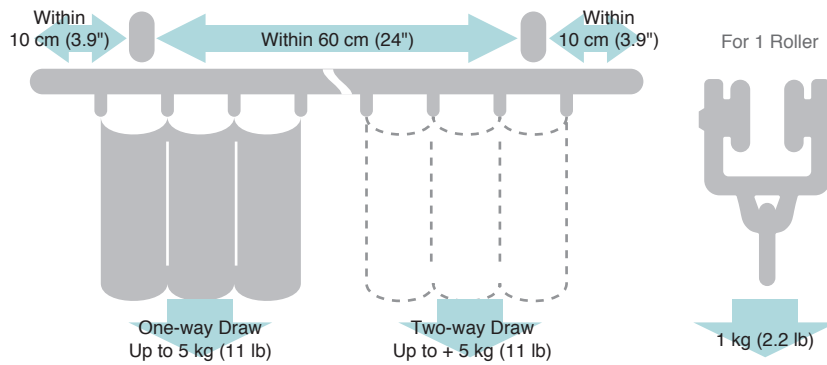

Installation Dimensions

Ceiling Attachment

Easy Snap Ceiling Single Bracket
Bracket width = 18 mm (.71")

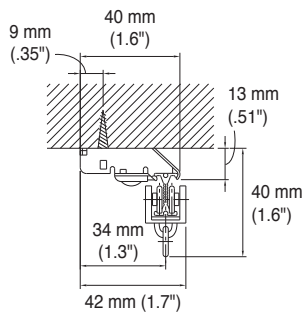

Ceiling Single Bracket
Bracket width = 14 mm (.55")

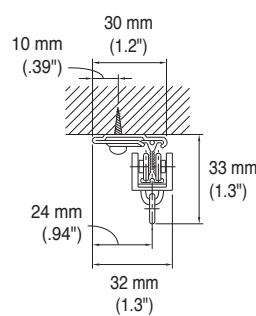

Easy Snap Ceiling Double Bracket
Bracket width = 19 mm (.75")

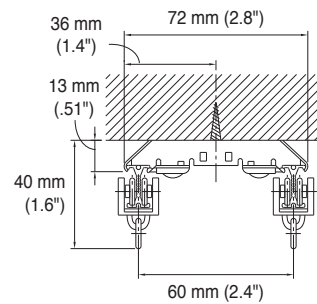

Ceiling Double Bracket
Bracket width = 18 mm (.71")

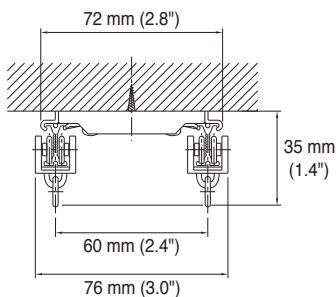

Wall Attachment

Single Bracket

Bracket width = 18 mm (.71")

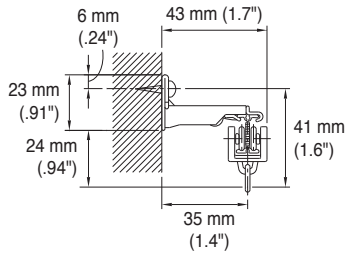

Extra Double Bracket

Bracket width = 24 mm (.94")

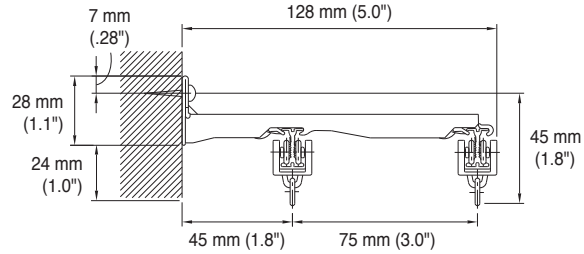

Double Bracket

Bracket width = 18 mm (.71")

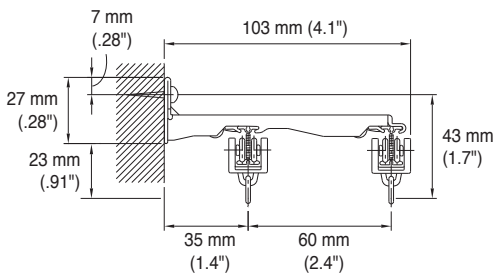

Valance Double Bracket

Bracket width = 18 mm (.71")

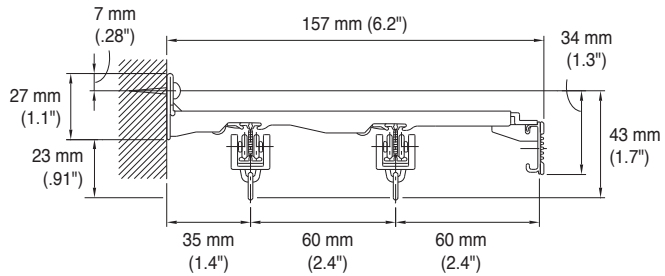

Selfie Rails

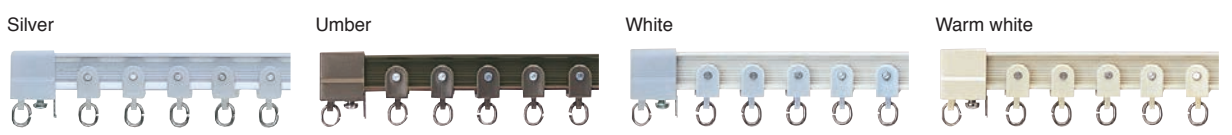

| Size | Product Code | | | |
|---------------|--------------|----------|----------|------------|
| | Silver | Umber | White | Warm white |
| 1.82 m (72") | 02330097 | 02330036 | 02330200 | 02330030 |
| 2.00 m (79") | 02330098 | 02330037 | 02330201 | 02330031 |
| 2.73 m (107") | 02330099 | 02330038 | 02330202 | 02330032 |
| 3.00 m (118") | 02330100 | 02330039 | 02330203 | 02330033 |
| 3.64 m (143") | 02330101 | 02330040 | 02330204 | 02330034 |
| 4.00 m (157") | 02330102 | 02330041 | 02330205 | 02330035 |

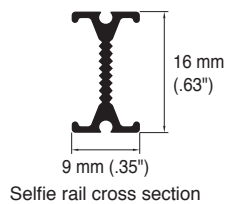

New Valance Rails



| Size | Product Code |
|---------------|--------------|
| | Warm white |
| 2.37 m (93") | 02330051 |
| 3.37 m (133") | 02330052 |



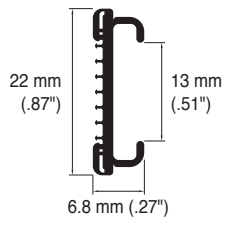





10 rails per box (not including separately manufactured rails)

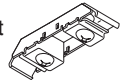









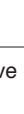

New Valance rail cross section with a Velcro (hooks)

Selfie Parts

| Product Name | | Product Code | |
|-------------------------------------------------------------------------------------------------------------------------|---------------------------------------------------------------------------------------------------------------------|--------------|----------|
| Rollers | Roller (8 pieces per strip)  | Natural | 02330107 |
| | | Umber | 02330019 |
| | | Warm white | 02330020 |
| | MG Carrier  | Natural | 02330108 |
| | | Umber | 02330021 |
| | | Warm white | 02330022 |
| | One-way MG Carrier  | Natural | 02330109 |
| | | Umber | 02330023 |
| | | Warm white | 02330024 |
| Brackets | Single Bracket  | Silver | 02330111 |
| | | Umber | 02330001 |
| | | Warm white | 02330002 |
| | Double Bracket  | Silver | 02330112 |
| | | Umber | 02330003 |
| | | Warm white | 02330004 |
| | Extra Double Bracket  | Silver | 02330113 |
| | | Umber | 02330076 |
| | | Warm white | 02330077 |
| Valance Double Bracket  | Warm White | 02330006 | |
| Easy Snap Ceiling Single Bracket  | Silver | 02330116 | |
| | Umber | 02330055 | |
| | Warm white | 02330054 | |

| Product Name | | Product Code | |
|----------------------------------------------------------------------------------------------------------|-----------------------------------------------------------------------------------------------------------------------|--------------|----------|
| Brackets | Ceiling Single Bracket  | Silver | 02330114 |
| | | Umber | 02330007 |
| | | Warm white | 02330008 |
| | Easy Snap Ceiling Double Bracket  | Silver | 02330117 |
| | | Umber | 02330057 |
| | | Warm white | 02330056 |
| | Ceiling Double Bracket  | Silver | 02330115 |
| | | Umber | 02330009 |
| | | Warm white | 02330010 |
| Wall Bracket  | Silver | 02330118 | |
| | Umber | 02330011 | |
| | Warm white | 02330012 | |
| Overhead Hanger  | Silver | 02330119 | |
| | Umber | 02330025 | |
| | Warm white | 02330026 | |
| Corner Support  | Warm White | 02330014 | |
| End Cap  | Natural | 02330110 | |
| | Umber | 02330015 | |
| | Warm white | 02330016 | |
| Intermediate Stop  | Natural | 02330018 | |
| Joint Pin  | | 02330027 | |

| Product Name | | Product Code | | |
|-----------------------------------------------------------------------------------------------------------------------------|-------------------------------------------------------------------------------------------------------------------------|--------------------------------------------------------------------------------------------------------------------------|----------|----------|
| Adjustable Hanger Rod B | B400 (250–400 mm/ 9.8–16")  | Umber | 00290013 | |
| | | White | 00290026 | |
| | B700 (400–700 mm/ 16–28")  | Umber | 00290012 | |
| | | White | 00290025 | |
| | Adjustable Hanger Rod A | A170 (130–170 mm/ 5.1–6.7")  | Silver | 00290034 |
| | | | White | 00290038 |
| Warm white | | | 00290035 | |
| A250 (170–250 mm/ 6.7–9.8")  | | Silver | 00290036 | |
| | | White | 00290039 | |
| | | Warm white | 00290037 | |
| A400 (245–400 mm/ 9.6–16")  | | Silver | 00290017 | |
| | | White | 00290040 | |
| | | Warm white | 00290030 | |
| A700 (395–700 mm/ 16–28")  | | Silver | 00290016 | |
| | | White | 00290041 | |
| | | Warm white | 00290031 | |
| A1100 (595–1,100 mm/ 23–43")  | Silver | 00290015 | | |
| | White | 00290042 | | |
| | Warm white | 00290032 | | |
| A1600 (845–1,600 mm/ 33–63")  | Silver | 00290014 | | |
| | White | 00290043 | | |
| | Warm white | 00290033 | | |
| Curve Bender 55R | |  | 02330028 | |
| Curve Bender 115R | |  | 02330029 | |
| Partial Bender | | | 00950027 | |